

80E Voltage Divider

Instruction Manual

P/N 293860
March 1965



WARRANTY

Notwithstanding any provision of any agreement the following warranty is exclusive:

The JOHN FLUKE MFG. CO., INC., warrants each instrument it manufactures to be free from defects in material and workmanship under normal use and service for the period of 1 year from date of purchase. This warranty extends only to the original purchaser. This warranty shall not apply to fuses, disposable batteries (rechargeable type batteries are warranted for 90 days), or any product or parts which have been subject to misuse, neglect, accident, or abnormal conditions of operations.

In the event of failure of a product covered by this warranty, John Fluke Mfg. Co., Inc., will repair and calibrate an instrument returned to an authorized Service Facility within 1 year of the original purchase; provided the warrantor's examination discloses to its satisfaction that the product was defective. The warrantor may, at its option, replace the product in lieu of repair. With regard to any instrument returned within 1 year of the original purchase, said repairs or replacement will be made without charge. If the failure has been caused by misuse, neglect, accident, or abnormal conditions of operations, repairs will be billed at a nominal cost. In such case, an estimate will be submitted before work is started, if requested.

THE FOREGOING WARRANTY IS IN LIEU OF ALL OTHER WARRANTIES, EXPRESS OR IMPLIED, INCLUDING BUT NOT LIMITED TO ANY IMPLIED WARRANTY OF MERCHANTABILITY, FITNESS, OR ADEQUACY FOR ANY PARTICULAR PURPOSE OR USE. JOHN FLUKE MFG. CO., INC., SHALL NOT BE LIABLE FOR ANY SPECIAL, INCIDENTAL, OR CONSEQUENTIAL DAMAGES, WHETHER IN CONTRACT, TORT, OR OTHERWISE.

If any failure occurs, the following steps should be taken:

1. Notify the JOHN FLUKE MFG. CO., INC., or nearest Service facility, giving full details of the difficulty, and include the model number, type number, and serial number. On receipt of this information, service data, or shipping instructions will be forwarded to you.
2. On receipt of the shipping instructions, forward the instrument, transportation prepaid. Repairs will be made at the Service Facility and the instrument returned, transportation prepaid.

SHIPPING TO MANUFACTURER FOR REPAIR OR ADJUSTMENT

All shipments of JOHN FLUKE MFG. CO., INC., instruments should be made via United Parcel Service or "Best Way" prepaid. The instrument should be shipped in the original packing carton; or if it is not available, use any suitable container that is rigid and of adequate size. If a substitute container is used, the instrument should be wrapped in paper and surrounded with at least four inches of excelsior or similar shock-absorbing material.

CLAIM FOR DAMAGE IN SHIPMENT TO ORIGINAL PURCHASER

The instrument should be thoroughly inspected immediately upon original delivery to purchaser. All material in the container should be checked against the enclosed packing list. The manufacturer will not be responsible for shortages against the packing sheet unless notified immediately. If the instrument is damaged in any way, a claim should be filed with the carrier immediately. (To obtain a quotation to repair shipment damage, contact the nearest Fluke Technical Center.) Final claim and negotiations with the carrier must be completed by the customer.

The JOHN FLUKE MFG. CO., INC., will be happy to answer all applications or use questions, which will enhance your use of this instrument. Please address your requests or correspondence to: JOHN FLUKE MFG. CO., INC., P.O. BOX C9090, EVERETT, WASHINGTON 98206, ATTN: Sales Dept. For European Customers: Fluke (Holland) B.V., P.O. Box 5053, 5004 EB, Tilburg, The Netherlands.

*For European customers, Air Freight prepaid.

John Fluke Mfg. Co., Inc., P.O. Box C9090, Everett, Washington 98206

Rev. 6/81

TABLE OF CONTENTS

Section	Title	Page
I	INTRODUCTION AND SPECIFICATIONS	1-1
	1-1. Introduction	1-1
	1-5. Specifications	1-1
	1-6. Electrical	1-1
	1-7. Mechanical	
II	OPERATING INSTRUCTIONS	2-1
	2-1. Operating Procedure	2-1
III	THEORY OF OPERATION	3-1
	3-1. Theory of Operation	3-1
IV	MAINTENANCE	4-1
	4-1. Introduction	4-1
	4-2. Troubleshooting	4-1
	4-5. Calibration of 80E-10.	4-1
	4-7. Calibration of 80E-5	4-2
V	LIST OF REPLACEABLE PARTS	5-1
	5-1. Introduction	5-1
	5-2. How to Obtain Parts	5-1
	5-3. Use Code Effectivity	5-5
	WARRANTY	
	CIRCUIT DIAGRAM	

LIST OF ILLUSTRATIONS

Figure	Title	Page
Frontispiece	80E Voltage Divider.	iv
4-1.	Equipment Required for Calibration	4-1
5-1.	Final Assembly.	5-1
5-2.	Calibration Assembly	5-3
5-3.	Divider Assembly.	5-4

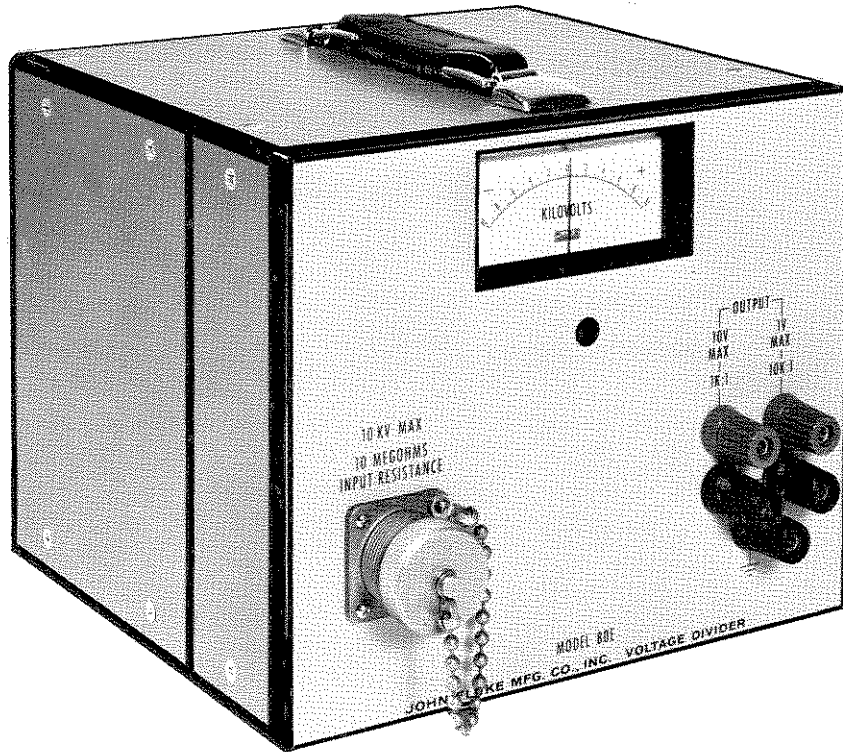

MODEL 80E VOLTAGE DIVIDER

SECTION I

INTRODUCTION AND SPECIFICATIONS

1-1. INTRODUCTION

1-2. The Model 80E Voltage Dividers extend the measuring range of Fluke differential voltmeters. The Model 80E-10 has a maximum input voltage of 10KV. The Model 80E-5 has a maximum input voltage of 5KV. Other input voltages are available on request. Both 10V and 1V output terminals are provided, which permit use of the 80E with Fluke differential voltmeters, or a null-type potentiometer.

1-3. A center zero panel meter permits observation of the approximate magnitude and polarity of the unknown voltage. In order to ensure maximum accuracy and long life, properly aged, wirewound resistors, having a very low temperature coefficient, are used throughout the instrument. The case of the instrument is suitable for either bench use or rack mounting.

1-4. This instrument has been thoroughly checked and tested before being shipped from the factory. Immediately after receiving the instrument, carefully inspect for any damage which may have occurred during transit. If any damage is noted, refer to the instructions outlined in the back of this manual.

1-5. SPECIFICATIONS

1-6. ELECTRICAL

ACCURACY: $\pm 0.01\%$ for both division ratios over a temperature range from 18°C to 28°C and for any input voltage up to rated maximum. Derate at $2\text{ ppm}/^{\circ}\text{C}$ outside this temperature range to 0°C and 50°C .

STABILITY OF DIVISION RATIO: $\pm 0.01\%$ per year (recalibrated by internal adjustment).

METER: Center zero panel meter for indicating approximate magnitude and polarity of unknown high voltage.

1-7. MECHANICAL

INPUT CONNECTOR: MS3102A-18-16S on front panel (mating connector supplied).

OUTPUT CONNECTORS: Two binding posts on $3/4''$ centers for each of two outputs. One side of each output is common to chassis. Separate binding post for grounding case. All output connectors located on front of instrument.

TEMPERATURE RANGE:
 0°C to 50°C (32°F to 122°F) operating
 -35°C to 70°C (-31°F to 158°F) storage

HUMIDITY:
 0 to 80% (to 28°C)
 0 to 60% (to 50°C)

ALTITUDE:
 0 to 10,000 feet operating
 0 to 50,000 feet non-operating

VIBRATION:
 MIL-T-945A.

SHOCK: Meets half sine (20g's, 11 milliseconds) shock and bench handling requirements of MIL-E-4970A.

SIZE:
 $7''$ high x $8-1/2''$ wide x $8''$ deep.

WEIGHT: Approximately 6 pounds.

Model	Division Ratio		Maximum Input	Current Drawn at Maximum Input	Total Input Resistance
	10V Max	1V Max			
80E-5	500:1	5,000:1	5 KV	1 ma	5 Meg
80E-10	1000:1	10,000:1	10 KV	1 ma	10 Meg



static awareness



A Message From
John Fluke Mfg. Co., Inc.

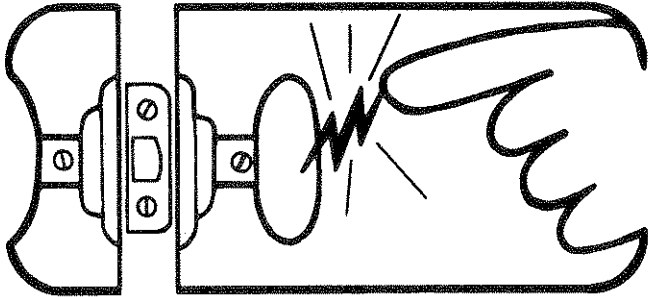

Some semiconductors and custom IC's can be damaged by electrostatic discharge during handling. This notice explains how you can minimize the chances of destroying such devices by:

1. Knowing that there is a problem.
2. Learning the guidelines for handling them.
3. Using the procedures, and packaging and bench techniques that are recommended.

The Static Sensitive (S.S.) devices are identified in the Fluke technical manual parts list with the symbol



The following practices should be followed to minimize damage to S.S. devices.

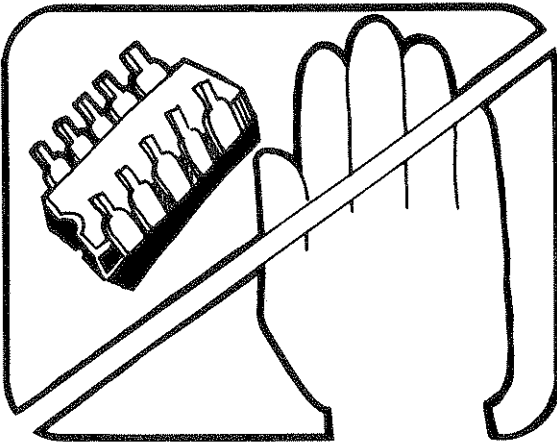

1. MINIMIZE HANDLING

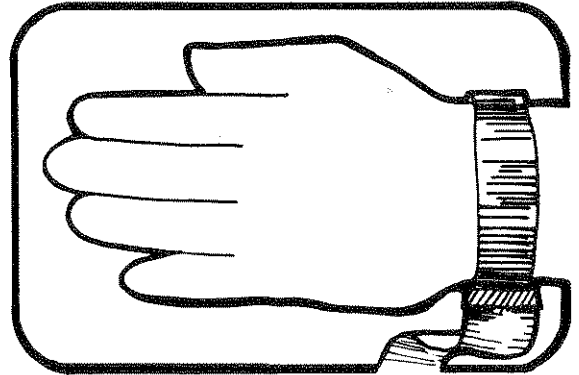

3. DISCHARGE PERSONAL STATIC BEFORE HANDLING DEVICES. USE A HIGH RESISTANCE GROUNDING WRIST STRAP.

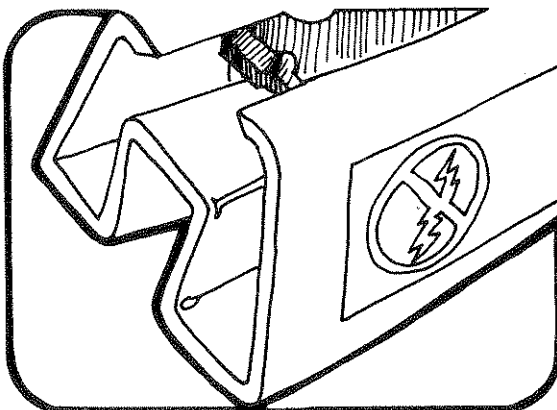

2. KEEP PARTS IN ORIGINAL CONTAINERS UNTIL READY FOR USE.

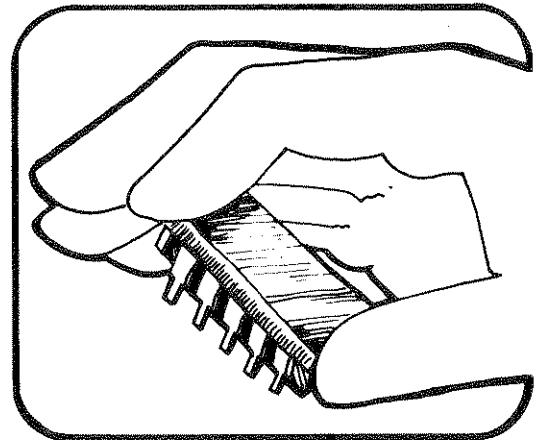

4. HANDLE S.S. DEVICES BY THE BODY

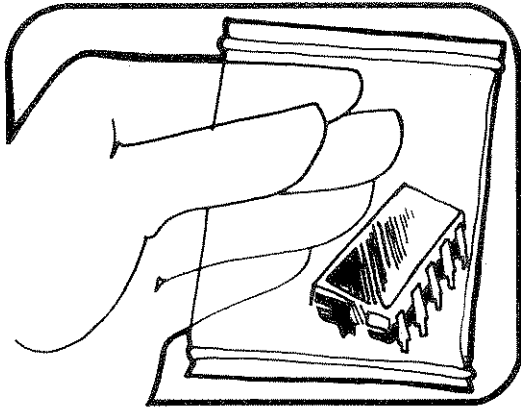

5. USE STATIC SHIELDING CONTAINERS FOR HANDLING AND TRANSPORT

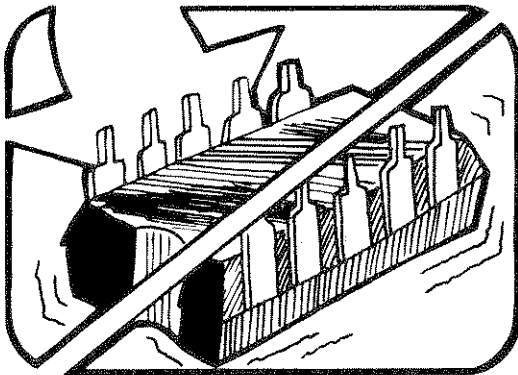

6. DO NOT SLIDE S.S. DEVICES OVER ANY SURFACE

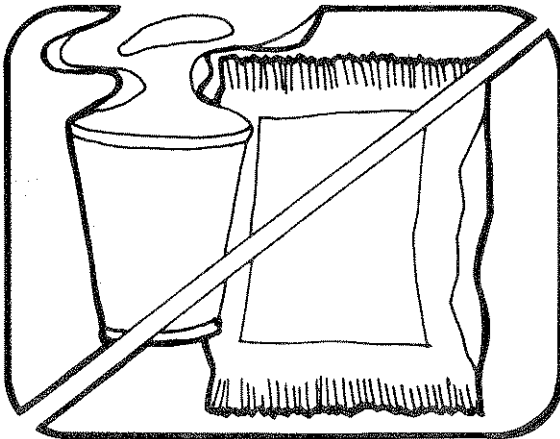

7. AVOID PLASTIC, VINYL AND STYROFOAM® IN WORK AREA

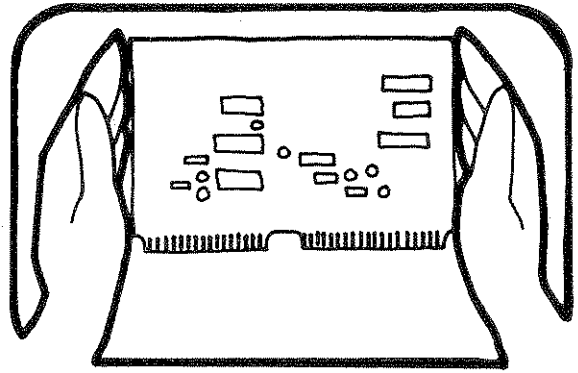

8. WHEN REMOVING PLUG-IN ASSEMBLIES, HANDLE ONLY BY NON-CONDUCTIVE EDGES AND NEVER TOUCH OPEN EDGE CONNECTOR EXCEPT AT STATIC-FREE WORK STATION. PLACING SHORTING STRIPS ON EDGE CONNECTOR HELPS TO PROTECT INSTALLED SS DEVICES.

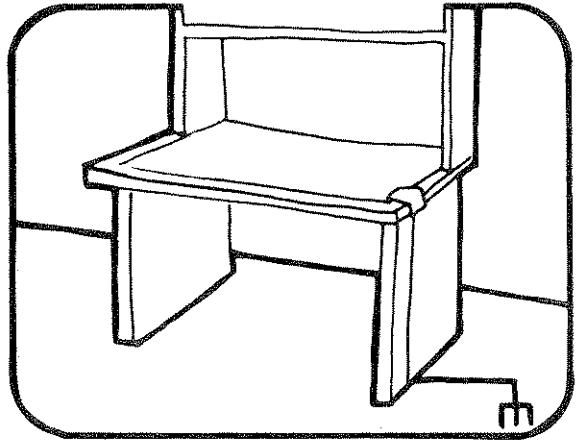

- 9. HANDLE S.S. DEVICES ONLY AT A STATIC-FREE WORK STATION
- 10. ONLY ANTI-STATIC TYPE SOLDER-SUCKERS SHOULD BE USED.
- 11. ONLY GROUNDED TIP SOLDERING IRONS SHOULD BE USED.

A complete line of static shielding bags and accessories is available from Fluke Parts Department, Telephone 800-526-4731 or write to:

JOHN FLUKE MFG. CO., INC.
 PARTS DEPT. M/S 86
 9028 EVERGREEN WAY
 EVERETT, WA 98204

PORTIONS REPRINTED
 WITH PERMISSION FROM TEKTRONIX, INC.
 AND GENERAL DYNAMICS, POMONA DIV.

SECTION II

OPERATING INSTRUCTIONS

2-1. OPERATING PROCEDURE

- a. Connect the ground side of the voltage to be measured to the ground terminal on the front panel. Please note that the shell of the large input connector is also connected to chassis ground.
- b. Connect the voltage to be measured to the large input connector.
- c. Connect a Fluke 800 series differential voltmeter to either set of output terminals. Voltages marked by

the OUTPUT terminals (10V and 1V) refer to the output voltage at maximum indicated input.

- d. Null the voltmeter to indicate the magnitude of the unknown voltage.
- e. If desired, instead of using the Fluke voltmeter in step c, a Leeds & Northrup Type K-3 Potentiometer may be connected to the 1V OUTPUT terminal, and adjusted to indicate the unknown voltage.

SECTION III

THEORY OF OPERATION

3-1. THEORY OF OPERATION

3-2. The 80E is a standard type of potentiometric voltage divider. Specified accuracy of the division ratio is obtained only when the instrument connected to the output terminals of the 80E has infinite input impedance. A voltmeter having 10 megohms input resistance will "load" the 10V output of the divider, causing an error of approximately 0.1%. Fluke differential voltmeters present infinite input impedance to the voltage divider at null, and consequently, cause no loading error.

3-3. Resistors used in the 80E are precision wirewound units having a low temperature coefficient, which promotes instrument accuracy and stability.

3-4. The overall accuracy of the panel meter, including the effects of series resistance, is approximately 3% of full scale. The meter is useful for indicating the approximate magnitude and polarity of the unknown voltage.

SECTION IV

MAINTENANCE

4-1. INTRODUCTION

4-2. The Model 80E Voltage Divider requires a minimum of maintenance. Occasionally, dust should be removed from the instrument by clean, dry, pressurized air. The front panel connectors may be cleaned using anhydrous alcohol. If the circuit boards require cleaning, they can also be cleaned with anhydrous alcohol.

4-2. TROUBLESHOOTING

4-3. The following two items are the only usual sources of trouble in the 80E:

a. Instability of the output voltage, which is usually caused by a short in one or more resistors.

b. Output voltage out-of-tolerance, which is usually caused by:

- (1) Dirty output connectors.
- (2) Dusty printed circuit boards.
- (3) A change in value of a resistor.

4-4. The remedy, as suggested by the preceding paragraph, is to clean the dusty or dirty surface, and/or replace the defective resistor.

4-5. CALIBRATION OF 80E-10

4-6. The division ratio accuracy of the 80E should be checked approximately every six months. The equipment required for calibration is listed in Figure 4-1.

NOTE

Full input voltage should be applied to the 80E for a minimum of 30 minutes prior to calibration.

a. CALIBRATION OF IV OUTPUT

(1) Connect the positive output terminal of the 301E to the 30V terminal of the 9700A and to the 10V OUTPUT terminal of the 80E. The connecting leads must be equal in length.

(2) Connect the 840A galvanometer between the 3V terminal of the 9700A and the 1V OUTPUT terminal of the 80E. Set the 840A to the 300-0-300 nanoampere range.

(3) Set the output of the 301E to 10V.

(4) Adjust R3, located on the calibration board, to null the 840A. As null is approached, the 840A may be set to a more sensitive range.

b. METER CALIBRATION

(1) Disconnect the Model 301E, and connect the positive output of a Fluke Model 410A to the large input connector of the 80E.

(2) Set the 410A for 10KV output.

(3) Adjust R4 for full-scale deflection of the panel meter.

c. CALIBRATION OF 10V OUTPUT

(1) Connect the positive output of the 410A to the 1500V terminal of the 9700A and to the 80E input connector. The connecting leads must be equal in length.

EQUIPMENT	SPECIFICATIONS
DC Power Supplies, Fluke Models 301E and 410A or equivalent.	Must provide stable outputs of 10V, and up to 10KV, respectively.
Galvanometer, Fluke Model 840A.	Null Detector. Sensitivities of 2 na per division and 20 na per division.
Volt Box, Sensitive Research, Type 9700A or equivalent.	Division ratios of 1,000 to 1 and 10,000 to 1. (500 to 1 and 5,000 to 1 for the 80E-5).

Figure 4-1. EQUIPMENT REQUIRED FOR CALIBRATION

(2) Connect the 840A between the 1.5V terminal of the 9700A and the 10V OUTPUT terminal of the 80E. Set the 840A to the 3-0-3 microampere range.

(3) Set the 410A for 750V output.

(4) Adjust R5, and then R6, to null the 840A. As null is approached, the 840A may be set to more sensitive ranges. If R5 and R6 do not provide sufficient resistance, the jumpers across R7, R8, and/or R9 can be removed.

4-7. CALIBRATION OF 80E-5

NOTE

Full input voltage should be applied to the 80E for a minimum of 30 minutes prior to calibration.

a. CALIBRATION OF IV OUTPUT

(1) Perform the steps indicated in paragraph 4-6a.

b. METER CALIBRATION

(1) Disconnect the Model 301E, and connect the positive output of a Fluke Model 410A to the large input connector of the 80E.

(2) Set the 410A for 5KV output.

(3) Adjust R4 for full-scale deflection of the panel meter.

c. CALIBRATION OF 10V OUTPUT

(1) Connect the positive 410A output terminal to the 1500V terminal of the 9700A and to the input terminal of the 80E-5. The connecting leads must be equal in length.

(2) Connect the 840A between the 3V terminal of the 9700A and the 10V OUTPUT terminal of the 80E. Set the 840A to the 3-0-3 microampere range.

(3) Set the 410A for 750V output.

(4) Adjust R5, and then R6, to null the 840A. As null is approached, the 840A may be set to more sensitive ranges. If R5 and R6 do not provide sufficient resistance, the jumpers across R7, R8, and/or R9 can be removed.

SECTION V

LIST OF REPLACEABLE PARTS

5-1. INTRODUCTION

The following list describes all normally replaceable parts of the Model 80E Voltage Divider. Parts are identified on the list by reference designations from the schematic diagram.

5-2. HOW TO OBTAIN PARTS

a. Most parts are standard components and can be obtained locally. All parts manufactured, altered, or

designed by Fluke are designated by an asterisk preceding the Fluke part number. All structural parts and all special parts should be ordered from your local Fluke representative or from the factory.

b. When ordering parts always include:

(1) Reference designation, description, and Fluke stock number.

(2) Instrument model and serial number.

c. Most structural parts are not listed in the following chart. To order these, give complete description, function and location of part.

REF DESIG	DESCRIPTION	STOCK NO	MFR	MFR PART NO	TOT QTY	REC QTY	USE CODE
	Final Assembly - Figure 5-1						
	Calibration Assembly - Figure 5-2						
R1	Res, ww, 1k, $\pm 0.01\%$, 1/2w	4707-166579	89536	4707-166579	1		A
R2	Res, ww, 8.998k $\pm 0.01\%$, 1/2w	4707-166587	89536	4707-166587	1		A
R1, R2	Resistor set, matched	4710-233072	89536	4710-233072	1		B
R3	Res, var, ww, $5\Omega \pm 20\%$, 1-1/4w	4702-166348	71450	Type 110	1		
R4	Res, var, ww, $200\Omega \pm 20\%$, 1-1/4w	4702-144766	71450	Type 110	1		
R5	Res, var, ww, $10k \pm 10\%$, 1/4w	4702-111641	80294	275-1-103	1		
R6	Res, var, ww, $100\Omega \pm 20\%$, 1-1/4w	4702-112797	71450	Type 110	1		
R7, R8, R9	Res, ww, 8k $\pm 0.02\%$, 1w	4707-131946	89536	4707-131946	3		
R10	Res, ww, 482k $\pm 0.1\%$, 1w	4707-166595	89536	4707-166595	1		

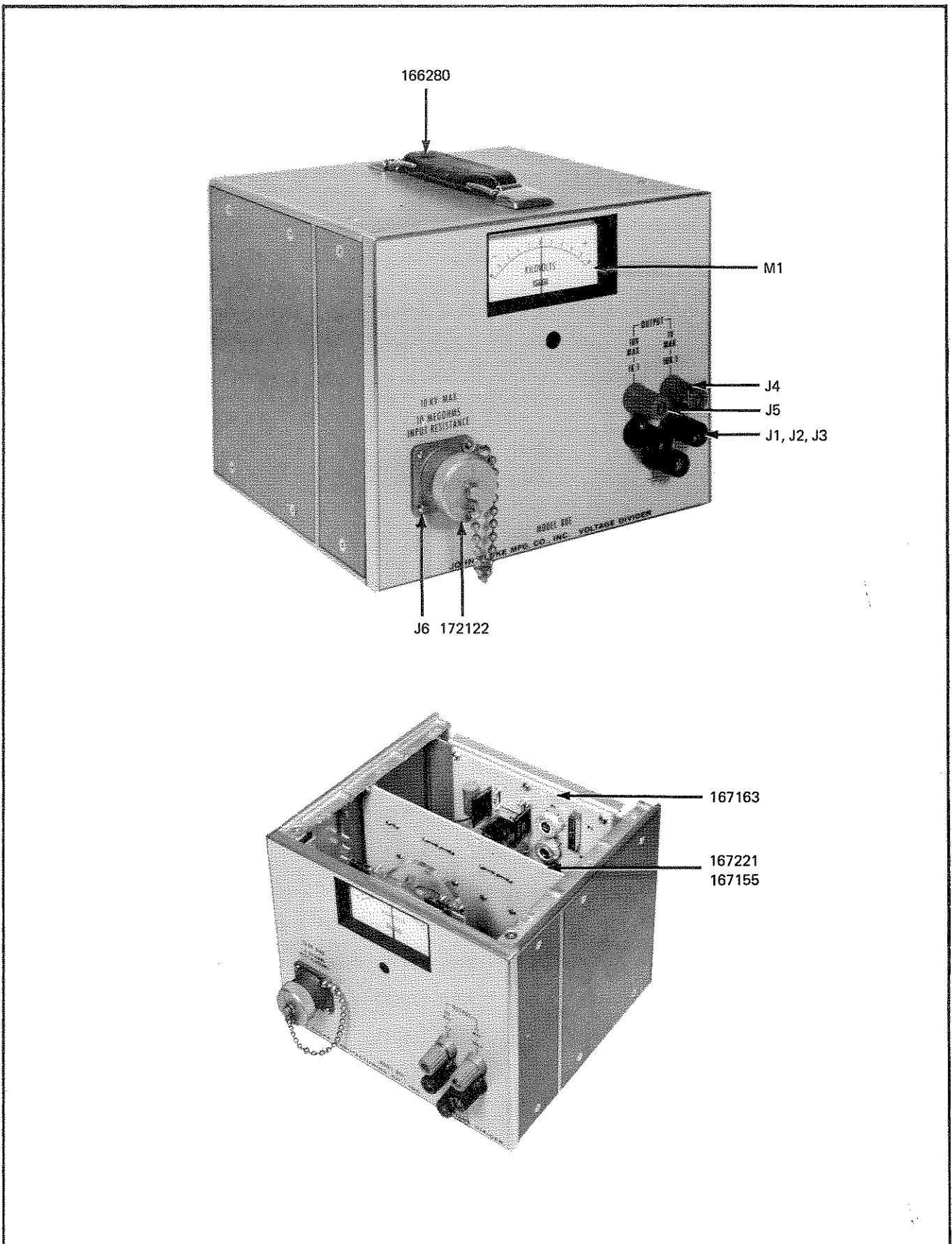

Figure 5-1. FINAL ASSEMBLY

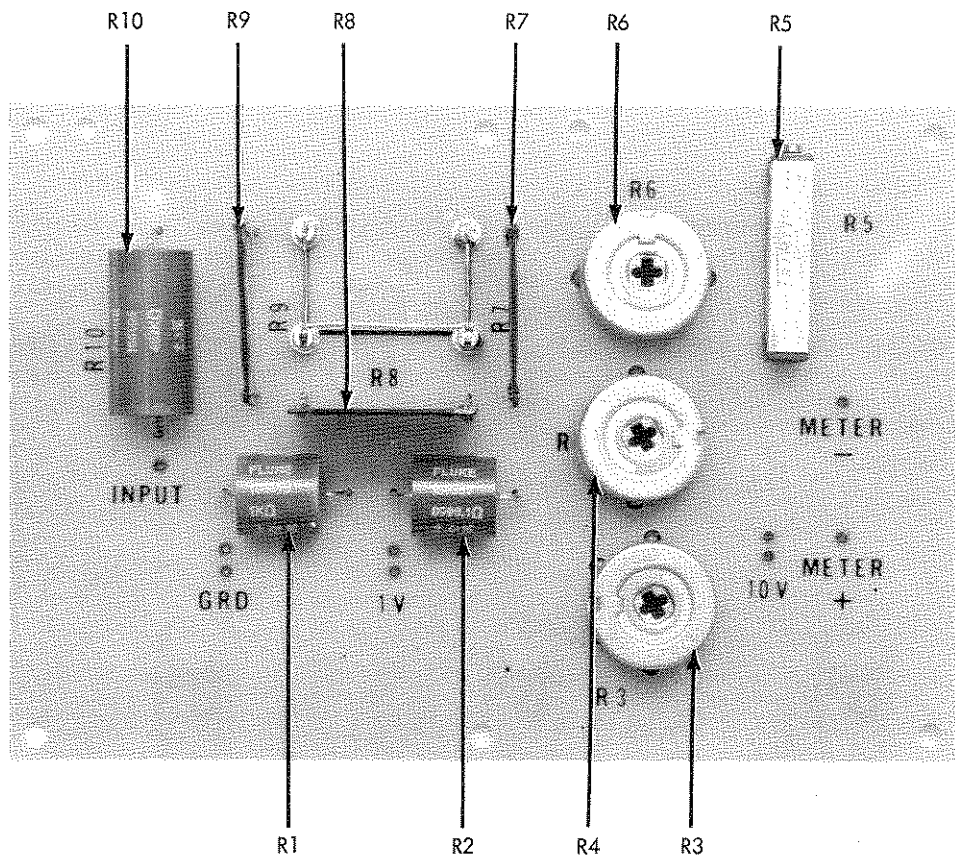

Figure 5-2. CALIBRATION ASSEMBLY

REF DESIG	DESCRIPTION	STOCK NO	MFR	MFR PART NO	TOT QTY	REC QTY	USE CODE
	Driver Assembly - Figure 5-3						
	80E-5 only	1702-167221	89536	1702-167221	1		
	80E-10 only	1702-167155	89536	1702-167155	1		
R11 thru R19	Res, ww, 500k \pm 0.1%, 1w (80E-5 only) (R11/R12, R13/R14, R15/R16, R17/R18 must be replaced in pairs.) (R11 thru R19 may be ordered as a set, part number 4710-223685.)	4707-192773	89536	4707-192773	9		
R11 thru R29	Res, ww, 500k \pm 0.1%, 1w (80E-10 only) (R11/R12, R13/R14, R15/R16, etc. must be replaced in pairs.) (R11 thru R29 may be ordered as a set, part number 4710-223701.)	4707-192773	89536	4707-192773	19		
J1, J2 J3	Binding post, black	2811-142984	58474	DF31BC	3		
J4, J5	Binding post, red	2811-142976	58474	DF31RC	2		
J6	Connector, high voltage	2104-208819	02660	MS3102A-18-16P	1		
M1	Meter, 1-0-1 ma	2901-167262	89536	2901-167262	1		
	Connector cap	3155-172122	89536	3155-172122	1		
	Mating connector (not illustrated)	2104-208827	02660	NS3106A-18-16S	1		
	Rubber supports	2819-103309	77969	9102-W	4		
	Handle, 4 inch	2404-166280	12136	919-415-173	1		
	Cable clamp (AN3057-10)	2104-100149	02660	AN3057-10	1		

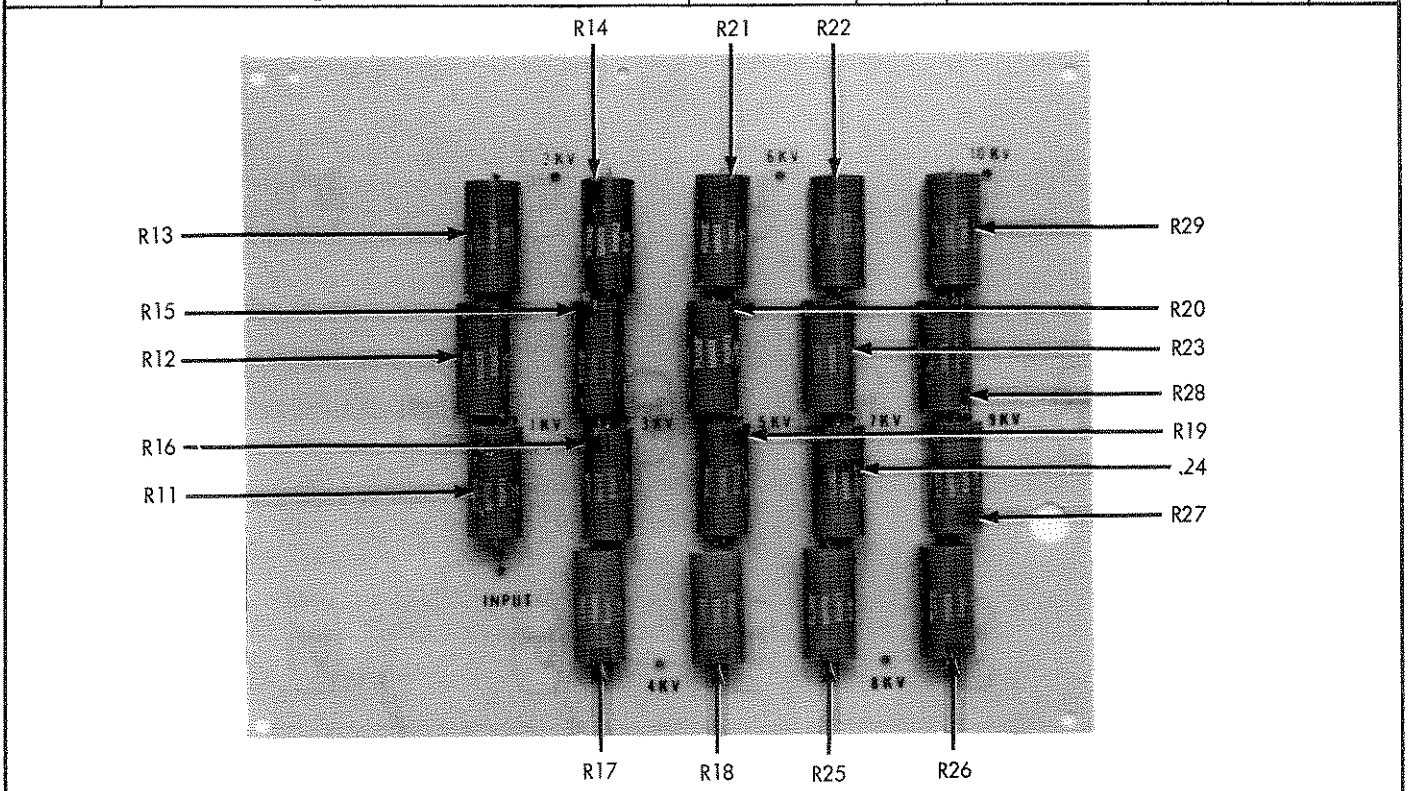
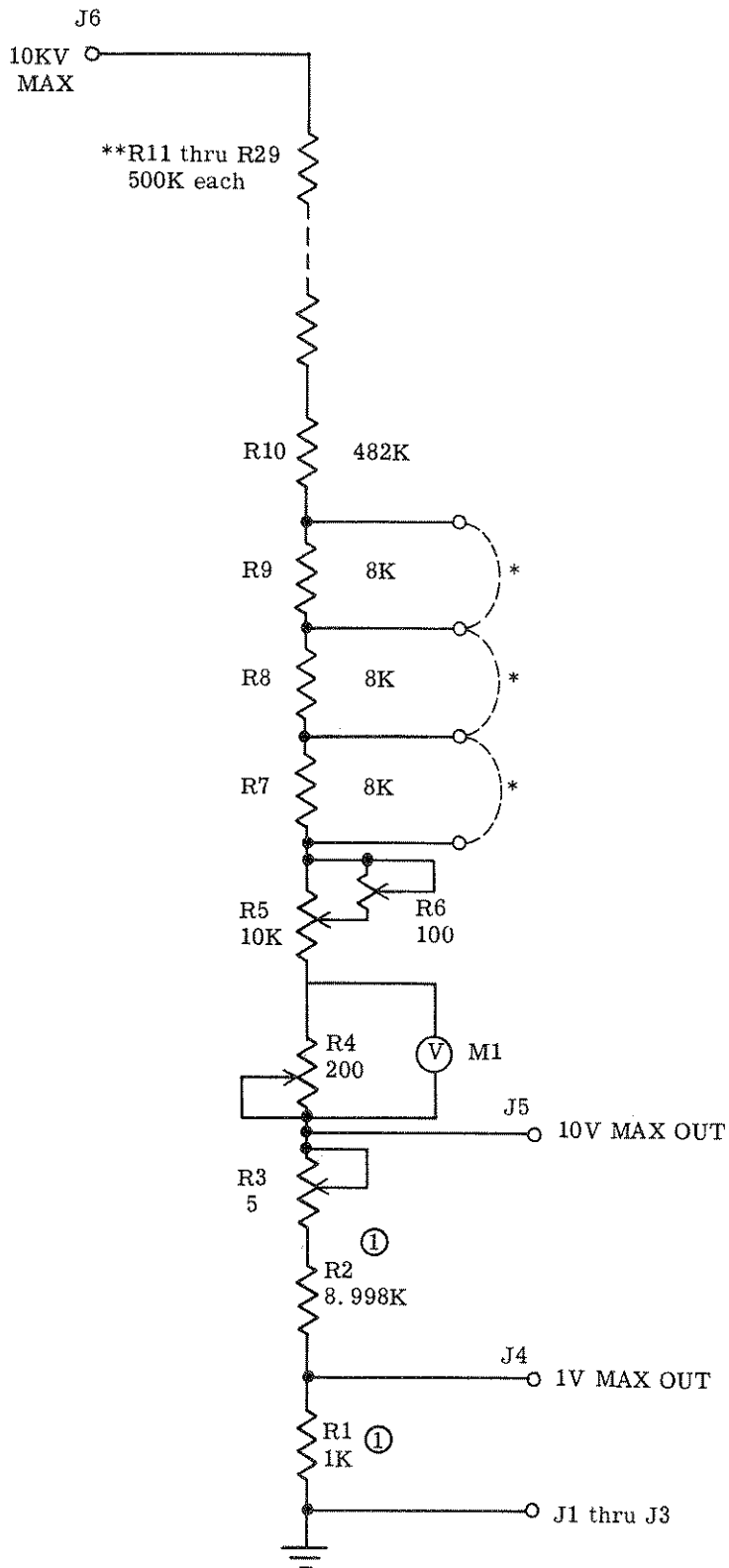

Figure 5-3. DIVIDER ASSEMBLY

5-3. USE CODE EFFECTIVITY

The following list of use codes is intended to allow the customer to determine the effectivity of all replaceable parts. All parts with no code are used on all instruments with serial numbers above 123. New codes will be added as necessary.

USE CODE	EFFECTIVITY
No Code	Model 80E serial number 123 and on
A	Model 80E serial number 123 to 459
B	Model 80E serial number 460 and on



*Calibration jumper

**Note: R20 thru R29 not used on 80E-5

① For Model 80E-5 & 80E-10 serial number 460 and on R1 & R2 changed to matched set

All resistors are in ohms and all capacitors are in microfarads unless otherwise noted.

FUNCTIONAL SCHEMATIC	
MODEL 80E-5 MODEL 80E-10	
VOLTAGE DIVIDER	
MODEL 80E-5	SER. NO. 123 & ON
MODEL 80E-10	SER. NO. 123 & ON
FLUKE JOHN FLUKE MFG. CO., INC.	

Section 7

General Information

7-1. This section of the manual contains generalized user information as well as supplemental information to the List of Replaceable Parts contained in Section 5.

List of Abbreviations and Symbols

A or amp	ampere	hf	high frequency	(+) or pos	positive
ac	alternating current	Hz	hertz	pot	potentiometer
af	audio frequency	IC	integrated circuit	p-p	peak-to-peak
a/d	analog-to-digital	if	intermediate frequency	ppm	parts per million
assy	assembly	in	inch(es)	PROM	programmable read-only memory
AWG	american wire gauge	intl	internal	psi	pound-force per square inch
B	bel	I/O	input/output	RAM	random-access memory
bcd	binary coded decimal	k	kilo (10 ³)	rf	radio frequency
°C	Celsius	kHz	kilohertz	rms	root mean square
cap	capacitor	kΩ	kiloohm(s)	ROM	read-only memory
ccw	counterclockwise	kV	kilovolt(s)	s or sec	second (time)
cer	ceramic	lf	low frequency	scope	oscilloscope
cermet	ceramic to metal(seal)	LED	light-emitting diode	SH	shield
ckt	circuit	LSB	least significant bit	Si	silicon
cm	centimeter	LSD	least significant digit	serno	serial number
cmrr	common mode rejection ratio	M	mega (10 ⁶)	sr	shift register
comp	composition	m	milli (10 ⁻³)	Ta	tantalum
cont	continue	mA	milliampere(s)	tb	terminal board
crt	cathode-ray tube	max	maximum	tc	temperature coefficient or temperature compensating
cw	clockwise	mf	metal film	tcxo	temperature compensated crystal oscillator
d/a	digital-to-analog	MHz	megahertz	tp	test point
dac	digital-to-analog converter	min	minimum	u or μ	micro (10 ⁻⁶)
dB	decibel	mm	millimeter	uhf	ultra high frequency
dc	direct current	ms	millisecond	us or μs	microsecond(s) (10 ⁻⁶)
dmm	digital multimeter	MSB	most significant bit	uut	unit under test
dvm	digital voltmeter	MSD	most significant digit	V	volt
elect	electrolytic	MTBF	mean time between failures	v	voltage
ext	external	MTTR	mean time to repair	var	variable
F	farad	mV	millivolt(s)	vco	voltage controlled oscillator
°F	Fahrenheit	mv	multivibrator	vhf	very high frequency
FET	Field-effect transistor	MΩ	megohm(s)	vlf	very low frequency
ff	flip-flop	n	nano (10 ⁻⁹)	W	watt(s)
freq	frequency	na	not applicable	ww	wire wound
FSN	federal stock number	NC	normally closed	xfrm	transformer
g	gram	(-) or neg	negative	xstr	transistor
G	giga (10 ⁹)	NO	normally open	xstal	crystal
gd	guard	ns	nanosecond	xtlo	crystal oscillator
Ge	germanium	opnl ampl	operational amplifier	Ω	ohm(s)
GHz	gigahertz	p	pico (10 ⁻¹²)	μ	micro (10 ⁻⁶)
gmV	guaranteed minimum value	para	paragraph		
gnd	ground	pcb	printed circuit board		
H	henry	pF	picofarad		
hd	heavy duty	pn	part number		

Federal Supply Codes for Manufacturers

D9816 Westermann Wilhelm Augusta-Anlage Mannheim-Nackarau Germany	02533 Leigh Instruments Ltd. Frequency Control Div. Don Mills, Ontario, Canada	04713 Motorola Inc. Semiconductor Group Phoenix, Arizona	06665 Precision Monolithics Sub of Bourns Inc. Santa Clara, California
00199 Marcon Electronics Corp Kearny, New Jersey	02606 Fenwal Labs Division of Travenal Labs Morton Grove, Illinois	05236 Jonathan Mfg. Co. Fullerton, California	06666 General Devices Co. Inc. Indianapolis, Indiana
00213 Nytronics Comp. Group Inc. Darlington, South Carolina	0266 Bunker Ramo-Eltra Corp. Amphenol NA Div. Broadview, Illinois	05245 Corcom Inc. Libertyville, Illinois	06739 Electron Corp. Littleton, Colorado
00327 Welwyn International Inc. Westlake, Ohio	02735 RCA-Solid State Div. Somerville, New Jersey	05276 ITT Pomona Electronics Div. Pomona, California	06743 Gould Inc. Foil Div. Eastlake, Ohio
00656 Aerovox Corp. New Bedford, Massachusetts	02799 Arco Electronics Inc. Chatsworth, California	05277 Westinghouse Elec. Corp. Semiconductor Div. Youngwood, Pennsylvania	06751 Components Inc. Semcor Div. Phoenix, Arizona
00686 Film Capacitors Inc. Passaic, New Jersey	03508 General Electric Co. Semiconductor Products & Batteries Auburn, New York	05397 Union Carbide Corp. Materials Systems Div. Cleveland, Ohio	06776 Robinson Nugent Inc. New Albany, Indiana
00779 AMP, Inc. Harrisburg, Pennsylvania	03797 Genisco Technology Corp. Eltronics Div. Rancho Dominguez, Calif.	05571 Sprague Electric Co. (Now 56289)	06915 Richco Plastic Co. Chicago, Illinois
01121 Allen Bradley Co. Milwaukee, Wisconsin	03877 Gilbert Engineering Co. Inc Incon Sub of Transitron Electronic Corp. Glendale, Arizona	05574 Viking Connectors Inc Sub of Criton Corp. Chatsworth, Calif.	06961 Vernitron Corp. Piezo Electric Div. Bedford, Ohio
01281 TRW Electronics & Defense Sector Lawndale, California	03888 KDI Electronics Inc. Pyrofilm Div. Whippany, New Jersey	05820 EG & G Wakefield Engineering Wakefield, Massachusetts	06980 Varian Associates Inc. Eimac Div. San Carlos, California
01295 Texas Instruments Inc. Semiconductor Group Dallas, Texas	03911 Clairex Corp. Clairex Electronics Div. Mount Vernon, New York	05972 Loctite Corp. Newington, Connecticut	07047 Ross Milton Co., The Southampton, Penna.
01537 Motorola Communications & Electronics Inc. Franklin Park, Illinois	03980 Muirhead Inc. Mountainside, New Jersey	06001 General Electric Co. Electric Capacitor Product Section Columbia, S. Carolina	07138 Westinghouse Electric Corp. Industrial & Government Tube Div. Horseheads, New York
01686 RCL Electronics/Shellcross Inc. Electro Components Div. Manchester, New Hampshire	04009 Cooper Industries, Inc. Arrow Hart Div. Hartford, Connecticut	06141 Fairchild Weston Systems Inc. Data Systems Div. Sarasota, Florida	07233 Benchmark Technology Inc. City of Industry, Calif.
01884 Sprague Electric Co. (Now 56289)	04217 Essex International Inc. Wire & Cable Div. Anaheim, California	06192 La Deau Mfg. Co. Glendale, California	07239 Biddle Instruments Blue Bell, Penna.
01961 Varian Associates Inc. Pulse Engineering Div. Convoy, Connecticut	04221 Midland-Ross Corp. Midtex Div. N. Mankato, Minnesota	06229 Electrovert Inc. Elmsford, New York	07256 Silicon Transistor Corp. Sub of BBF Inc. Chelmsford, Massachusetts
02111 Spectrol Electronics Corp. City of Industry, California	04222 AVX Corp. AVX Ceramics Div. Myrtle Beach, S. Carolina	06383 Panduit Corp. Tinley Park, Illinois	07261 Avnet Corp. Culver City, California
02114 Amperex Electronic Corp. Ferrox Cube Div. Saugerties, New York	04423 Telonic Berkley Inc. Laguna Beach, California	06473 Bunker Ramo Corp. Amphenol NA Div. SAMS Operation Chatsworth, California	07263 Fairchild Camera & Instrument Semiconductor Div. Mountain View, California
02131 General Instrument Corp. Government Systems Div. Westwood, Massachusetts		06555 Beede Electrical Instrument Penacook, New Hampshire	07344 Bircher Co. Inc., The Rochester, New York
02395 Sonar Radio Corp. Hollywood, Florida			

Federal Supply Codes for Manufacturers (cont)

07557 Campion Co. Inc. Philadelphia, Penna.	09423 Scientific Components Inc. Santa Barbara, California	11711 General Instrument Corp. Rectifier Div. Hicksville, New York	12954 Microsemi Corp. Components Group Scottsdale, Arizona
07597 Burndy Corp. Tape/Cable Div. Rochester, New York	09579 CTS of Canada, Ltd Streetsville, Ontario	11726 Qualidyne Corp. Santa Clara, California	12969 Unitrode Corp. Lexington, Massachusetts
07716 TRW Inc. (Can use 11502) IRC Fixed Resistors/ Burlington Burlington, Iowa	09922 Burndy Corp. Norwalk, Connecticut	12014 Chicago Rivet & Machine Co. Naperville, Illinois	13050 Potter Co. Wesson, Mississippi
07792 Lerma Engineering Corp. Northampton, Massachusetts	09969 Dale Electronics Inc. Yankton, South Dakota	12040 National Semiconductor Corp. Danbury, Connecticut	13103 Thermalloy Co., Inc. Dallas, Texas
07810 Bock Corp. Madison, Wisconsin	09975 Burroughs Corp. Electronics Components Detroit, Michigan	12060 Diodes Inc. Northridge, California	13327 Solitron Devices Inc. Tappan, New York
07933 Raytheon Co. Semiconductor Div. Mountain View, Calif.	10059 Barker Engineering Corp. Kenilworth, New Jersey	12136 PHC Industries Inc. Formerly Philadelphia Handle Co. Camden, New Jersey	13511 Bunker-Ramo Corp. Amphenol Cadre Div. Los Gatos, California
08235 Industro Transistor Corp. Long Island City, New York	10389 Illinois Tool Works Inc. Licon Div. Chicago, Illinois	12300 AMF Canada Ltd. Potter-Brumfield Guelph, Ontario, Canada	13606 Sprague Electric Co. (Use 56289)
08261 Spectra-Strip An Eltra Co. Garden Grove, Calif.	10582 CTS of Asheville Skyland, N. Carolina	12323 Practical Automation Inc. Shelton, Connecticut	13689 SPS Technologies Inc. Hatfield, Pennsylvania
08530 Reliance Mica Corp. Brooklyn, New York	11236 CFS Corp. Berne Div. Berne, Indiana	12327 Freeway Corp. Cleveland, Ohio	13919 Burr-Brown Research Corp. Tucson, Arizona
08718 ITT Cannon Electric Phoenix Div. Phoenix, Arizona	11237 CTS Corp of California Paso Robles Div. Paso Robles, California	12443 Budd Co.,The Plastics Products Div. Phoenixville, Pennsylvania	14099 Semtech Corp. Newbury Park, California
08806 General Electric Co. Miniature Lamp Products Cleveland, Ohio	11295 ECM Motor Co. Schaumburg, Illinois	12581 Hitachi Metals International Ltd. Hitachi Magna-Lock Div. Big Rapids, Missouri	14140 McGray-Edison Co. Commercial Development Div. Manchester, New Hampshire
08863 Nylomatic Fallsington, Penna.	11358 Columbia Broadcasting System CBS Electronic Div. Newburyport, Massachusetts	12615 US Terminals Inc. Cincinnati, Ohio	14193 Cal-R-Inc. Santa Monica, California
08988 Skottie Electronics Inc. Archbald, Pennsylvania	11403 Vacuum Can Co. Best Coffee Maker Div. Chicago, Illinois	12617 Hamlin Inc. Lake Mills, Wisconsin	14298 American Components Inc. an Insilco Co. RPC Div. Conshohocken, Pennsylvania
09021 Aircoc Inc. Aircoc Electronics Bradford, Penna.	11502 TRW Inc. TRW Resistive Products Div. Boone, North Carolina	12697 Clarostat Mfg. Co. Inc. Dover, New Hampshire	14298 ACIC Inc. Sub of Insilco Corp. Research Triangle Park, NC
09023 Cornell-Dublier Electronics Fuquay-Varina, N. Carolina	11503 Keystone Columbia Inc. Freemont, Indiana	12749 James Electronic Inc. Chicago, Illinois	14329 Wells Electronics Inc. South Bend, Indiana
09214 General Electric Co. Semiconductor Products Dept. Auburn, New York	11503 Keystone Columbia Inc. Freemont, Indiana	12856 MicroMetals Inc. Anaheim, California	14482 Watkins-Johnson Co. Palo Alto, California
09353 C and K Components Inc. Newton, Massachusetts	11532 Teledyne Relays Teledyne Industries Inc. Hawthorne, California	12881 Metex Corp. Edison, New Jersey	14552 Microsemi Corp. Santa Ana, California
		12895 Cleveland Electric Motor Co. Cleveland, Ohio	14655 Cornell-Dublier Electronics Div. of Federal Pacific Electric Co. Govt Cont Dept. Newark, New Jersey

Federal Supply Codes for Manufacturers (cont)

14704 Crydom Controls (Division of Int Rectifier) El Segundo, California	16733 Cablewave Systems Inc. North Haven, Connecticut	18927 GTE Products Corp. Precision Material Products Business Parts Div. Titusville, Pennsylvania	23936 William J. Purdy Co. Pamotor Div. Burlingame, California
14752 Electro Cube Inc. San Gabriel, California	16742 Paramount Plastics Fabricators Inc. Downey, California	19315 Bendix Corp., The Navigation & Control Group Teaboro, New Jersey	24347 Penn Engineering Co. S. El Monte, California
14936 General Instrument Corp. Discrete Semi Conductor Div. Hicksville, New York	16758 General Motors Corp. Delco Electronics Div. Kokomo, Indiana	19451 Perine Machinery & Supply Co.. Kent, Washington	24355 Analog Devices Inc. Norwood, Massachusetts
14949 Trompeter Electronics Chatsworth, California	17069 Circuit Structures Lab Burbank, California	19613 Minnesota Mining & Mfg. Co. Textool Products Dept. Electronic Product Div. Irving, Texas	24444 General Semiconductor Industries, Inc. Tempe, Arizona
15412 Amtron Midlothian, Illinois	17117 Electronic Molding Corp. Woonsocket, Rhode Island	19647 Caddock Electronics Inc. Riverside, California	24655 Genrad Inc. Concord, Massachusetts
15542 Scientific Components Corp. Mini-Circuits Laboratory Div. Brooklyn, New York	17338 High Pressure Eng. Co. Inc. Oklahoma City, Oklahoma	19701 Mepco/Centralab Inc. A N. American Philips Co. Mineral Wells, Texas	24759 Lenox-Fugle Electronics Inc. South Plainfield, New Jersey
15636 Elec-Trol Inc. Saugus, California	17545 Atlantic Semiconductors Inc. Asbury Park, New Jersey	20584 Angstrom Precision, Inc. Hagerstown, Maryland	24796 AMF Inc. Potter & Brumfield Div. San Juan Capistrano, Calif.
15782 Bausch & Lomb Inc. Graphics & Control Div. Austin, Texas	17856 Siliconix Inc. Santa Clara, California	20891 Cosar Corp. Dallas, Texas	24931 Specialty Connector Co. Greenwood, Indiana
15801 Fenwal Electronics Inc. Div. of Kidde Inc. Framingham, Massachusetts	18178 E G & Gvactee Inc. St. Louis, Missouri	21317 Electronics Applications Co. El Monte, California	25088 Siemen Corp. Isilen, New Jersey
15818 Teledyne Inc. Co. Teledyne Semiconductor Div. Mountain View, California	18324 Signetics Corp. Sacramento, California	21604 Buckeye Stamping Co. Columbus, Ohio	25099 Cascade Gasket Kent, Washington
15849 Useco Inc. (Now 88245)	18520 Sharp Electronics Corp. Paramus, New Jersey	21845 Solitron Devices Inc. Semiconductor Group Rivera Beach, Florida	25403 Amperex Electronic Corp. Semiconductor & Micro-Circuit Div. Slatersville, Rhode Island
15898 International Business Machines Corp. Essex Junction, Vermont	18542 Wabash Inc. Wabash Relay & Electronics Div. Wabash, Indiana	22526 DuPont, EI DeNemours & Co. Inc. DuPont Connector Systems Advanced Products Div. New Cumberland, Pennsylvania	25706 Daburn Electronic & Cable Corp. Norwood, New Jersey
16245 Conap Inc. Olean, New York	18565 Chomerics Inc. Woburn, Massachusetts	22767 ITT Semiconductors Palo Alto, California	26629 Frequency Sources Inc. Sources Div. Chelmsford, Massachusetts
16258 Space-Lok Inc. Burbank, California	18612 Vishay Intertechnology Inc. Vishay Resistor Products Group Malvern, Pennsylvania	22784 Palmer Inc. Cleveland, Ohio	26806 American Zettler Inc. Irvine, California
16352 Codi Corp. Linden, New Jersey	18632 Norton-Chemplast Santa Monica, California	23050 Product Comp. Corp. Mount Vernon, New York	27014 National Semiconductor Corp. Santa Clara, California
16469 MCL Inc. LaGrange, Illinois	18677 Scanbe Mfg. Co. Div. of Zero Corp. El Monte, California	23732 Tracor Applied Sciences Inc. Rockville, Maryland	27167 Corning Glass Works Corning Electronics Wilmington, North Carolina
16473 Cambridge Scientific Industries Div. of Chemed Corp. Cambridge, Maryland	18736 Voltronics Corp. East Hanover, New Jersey	23880 Stanford Applied Engineering Santa Clara, California	27264 Molex Inc. Lisle, Illinois
			27440 Industrial Screw Products Los Angeles, California

Federal Supply Codes for Manufacturers (cont)

27745 Associated Spring Barnes Group Inc. Syracuse, New York	30800 General Instrument Corp. Capacitor Div. Hicksville, New York	33297 NEC Electronics USA Inc. Electronic Arrays Inc. Div. Mountain View, California	49956 Raytheon Company Executive Offices Lexington, Massachusetts
27956 Relcom (Now 14482)	31019 Solid State Scientific Inc. Willow Grove, Pennsylvania	33919 Nortek Inc. Cranston, Rhode Island	50088 Thomson Components-Mostek Corp. Carrollton, Texas
28198 Positronic Industries Springfield, Missouri	31091 Alpha Industries Inc. Microelectronics Div. Hatfield, Pennsylvania	34333 Silicon General Inc. Garden Grove, California	50120 Eagle-Picher Industries Inc. Electronics Div. Colorado Springs, Colorado
28213 Minnesota Mining & Mfg. Co. Consumer Products Div. 3M Center Saint Paul, Minnesota	31323 Metro Supply Company Sacramento, California	34225 Advanced Micro Devices Sunnyvale, California	50157 Midwest Components Inc. Muskegon, Mississippi
28425 Serv-O-Link Euless, Texas	31448 Army Safeguard Logistics Command Huntsville, Alabama	34359 Minnesota Mining & Mfg. Co. Commercial Office Supply Div. Saint Paul, Minnesota	50541 Hypertronics Corp. Hudson, Massachusetts
28478 Deltrol Corporation Deltrol Controls Div. Milwaukee, Wisconsin	31746 Cannon Electric Woodbury, Tennessee	34371 Harris Corp. Harris Semiconductor Products Group Melbourne, Florida	50579 Litronix Inc. Cupertino, California
28480 Hewlett Packard Co. Corporate HQ Palo Alto, California	31827 Budwig Ramona, California	34649 Intel Corp. Santa Clara, California	51167 Aries Electronics Inc. Frenchtown, New Jersey
28484 Emerson Electric Co. Gearmaster Div. McHenry, Illinois	31918 ITT-Schadow Eden Prairie, Minnesota	34802 Electromotive Inc. Kenilworth, New Jersey	51372 Verbatim Corp. Sunnyvale, California
28520 Heyco Molded Products Kenilworth, New Jersey	32293 Intersil Cupertino, California	34848 Hartwell Special Products Placentia, California	51406 Murata Erie, No. America Inc. (Also see 72982) Marietta, Georgia
29083 Monsanto Co. Santa Clara, California	32539 Mura Corp. Westbury, Long Island, N.Y.	35009 Renfrew Electric Co. Ltd. IRC Div. Toronto, Ontario, Canada	51499 Amtron Corp. Boston, Massachusetts
29604 Stackpole Components Co. Raleigh, North Carolina	32559 Bivar Santa Ana, California	36665 Mitel Corp. Kanata, Ontario, Canada	51605 CODI Semiconductor Inc. Kenilworth, New Jersey
29907 Omega Engineering Inc. Stamford, Connecticut	32767 Griffith Plastics Corp. Burlingame, California	37942 Mallory Capacitor Corp. Sub of Ernhart Industries Indianapolis, Indiana	51642 Centre Engineering Inc. State College, Pennsylvania
30035 Jolo Industries Inc. Garden Grove, California	32879 Advanced Mechanical Components Northridge, California	39003 Maxim Industries Middleboro, Massachusetts	51791 Statek Corp. Orange, California
30146 Symbex Corp. Painesville, Ohio	32897 Murata Erie North America Inc. Carlisle Operations Carlisle, Pennsylvania	40402 Roderstein Electronics Inc. Statesville, North Carolina	51984 NEC America Inc. Falls Church, Virginia
30148 AB Enterprise Inc. Ahoskie, North Carolina	32997 Bourns Inc. Trimpot Div. Riverside, California	42498 National Radio Melrose, Massachusetts	52063 Exar Integrated Systems Sunnyvale, California
30161 Aavid Engineering Inc. Laconia, New Hampshire	33096 Colorado Crystal Corp. Loveland, Colorado	43543 Nytronics Inc.(Now 53342)	52072 Circuit Assembly Corp. Irvine, California
30315 Itron Corp. San Diego, California	33173 General Electric Co. Owensboro, Kentucky	44655 Ohmite Mfg. Co. Skokie, Illinois	52152 Minnesota Mining & Mfg. Saint Paul, Minnesota
30323 Illinois Tool Works Inc. Chicago, Illinois	33246 Epoxy Technology Inc. Billerica, Massachusetts	49671 RCA Corp. New York, New York	52333 API Electronics Haugauge, Long Island, New York

Federal Supply Codes for Manufacturers (cont)

52361 Communication Systems Piscataway, New Jersey	54590 RCA Corp. Electronic Components Div. Cherry Hill, New Jersey	58104 Simco Atlanta, Georgia	64155 Linear Technology Milpitas, California
52525 Space-Lok Inc. Lerco Div. Burbank, California	55026 American Gage & Machine Co. Simpson Electric Co. Div. Elgin, Illinois	58474 Superior Electric Co. Bristol, Connecticut	64834 West M G Co. San Francisco, Calif.
52531 Hitachi Magnetics Edmore, Missouri	55112 Plessey Capacitors Inc. (Now 60935)	59124 KOA-Speer Electronics Inc. Bradford, Pennsylvania	65092 Sangamo Weston Inc. Weston Instruments Div. Newark, New Jersey
52745 Timco Los Angeles, California	55261 LSI Computer Systems Inc. Melville, New York	59640 Supertex Inc. Sunnyvale, California	65940 Rohm Corp & Whatney Irvine, California
52763 Stettner-Electronics Inc. Chattanooga, Tennessee	55285 Beroquist Co. Minneapolis, Minnesota	59660 Tusonix Inc. Tucson, Arizona	65964 Evox Inc. Bannockburn, Illinois
52769 Sprague-Goodman Electronics Inc. Garden City Park, New York	55576 Synertek Santa Clara, California	59730 Thomas and Betts Corp. Iowa City, Iowa	66150 Entron Inc. Winslow Teltronics Div. Glendale, New York
52771 Monitem Corp. Amatrom Div. Santa Clara, California	55680 Michicon/America/Corp. Schaumburg, Illinois	59831 Semtronics Corp. Watchung, New Jersey	66608 Bech Industries Fremont, California
52840 Western Digital Corp. Costa Mesa, California	56282 Utek Systems Inc. Olathe, Kansas	60395 Xicor Inc. Milpitas, California	70290 Almetal Universal Joint Co. Cleveland, Ohio
53021 Sangamo Weston Inc. (See 06141)	56289 Sprague Electric Co. North Adams, Massachusetts	60399 Torin Engineered Blowers Div. of Clevepak Corp. Torrington, Connecticut	70485 Atlantic India Rubber Works Inc. Chicago, Illinois
53217 Technical Wire Products Inc. Santa Barbara, California	56365 Square D Co. Corporate Offices Palatine, Illinois	60705 Cera-Mite Corp. (formerly Sprague) Grafton, Wisconsin	70563 Amperite Company Union City, New Jersey
53342 Opt Industries Inc. Phillipsburg, New Jersey	56375 DAL Industries Inc. Wescorp Div. Mountain View, California	60935 Westlake Capacitor Inc. Tantalum Div. Greencastle, Indiana	70903 Beiden Corp. Geneva, Illinois
53944 Glow-Lite Pauls Valley, Oklahoma	56481 Shugart Associates Sub of Xerox Corp. Sunnyvale, California	61804 M/A Com Inc. Burlington, Massachusetts	71002 Bimbach Co. Inc. Farmingdale, New York
54294 Shallcross Inc. Smithfield, North Carolina	56708 Zilog Inc. Campbell, California	61857 SAN-O Industrial Corp. Bohemia, Long Island, NY	71034 Bliley Electric Co. Erie, Pennsylvania
54453 Sullins Electronic Corp. San Marcos, California	56856 Varnistor Corp. of Tennessee Sevierville, Tennessee	61935 Schurter Inc. Petaluma, California	71183 Westinghouse Electric Corp. Bryant Div. Bridgeport, Connecticut
54473 Matsushita Electric Corp. (Panasonic) Secaucus, New Jersey	56880 Magnetics Inc. Baltimore, Maryland	62351 Apple Rubber Lancaster, New York	71400 Bussman Manufacturing Div. McGraw-Edison Co. St. Louis, Missouri
54583 TDK Garden City, New York	57026 Endicott Coil Co. Inc. Binghamton, New York	62793 Lear Siegler Inc. Energy Products Div. Santa Ana, California	71450 CTS Corp. Elkhart, Indiana
54869 Pihor International Corp. Arlington Heights, Illinois	57053 Gates Energy Products Denver, Ohio	63743 Ward Leonard Electric Co. Inc. Mount Vernon, New York	71468 ITT Cannon Div. of ITT Fountain Valley, California
54937 DeYoung Mfg. Bellevue, Washington	58014 Hitachi Magnalock Corp. (Now 12581)	64154 Lamb Industries Portland, Oregon	71482 General Instrument Corp. Clare Div. Chicago, Illinois

Federal Supply Codes for Manufacturers (cont)

71590 Mepco/Centralab A North American Philips Co. Fort Dodge, Iowa	73445 Amperex Electronic Corp. Hicksville, New York	75378 CTS Knights Inc. Sandwich, Illinois	79727 C - W Industries Southampton, Pennsylvania
71707 Coto Corp. Providence, Rhode Island	73559 Carlingswitch Inc. Hartford, Connecticut	75382 Kulka Electric Corp. (Now 83330) Mount Vernon, New York	79963 Zierick Mfg. Corp. Mount Kisco, New York
71744 General Instrument Corp. Lamp Div/Worldwide Chicago, Illinois	73586 Circle F Industries Trenton, New Jersey	75915 Tracor Littlefuse Des Plaines, Illinois	80009 Tektronix Beaverton, Oregon
71785 TRW Inc. Cinch Connector Div. Elk Grove Village, Illinois	73734 Federal Screw Products Inc. Chicago, Illinois	76854 Oak Switch Systems Inc. Crystal Lake, Illinois	80031 Mepco/Electra Inc. Morristown, New Jersey
71984 Dow Corning Corp. Midland, Michigan	73743 Fischer Special Mfg. Co. Cold Spring, Kentucky	77122 TRW Assemblies & Fasteners Group Fastener Div. Moutainside, New Jersey	80032 Ford Aerospace & Communications Corp. Western Development Laboratories Div. Palo Alto, California
72005 AMAX Specialty Metals Corp. Newark, New Jersey	73893 Microdot Mt. Clemens, Mississippi	77342 AMF Inc. Potter & Brumfield Div. Princeton, Indiana	80145 LFE Corp. Process Control Div. Clinton, Ohio
72136 Electro Motive Mfg. Corp. Florence, South Carolina	73899 JFD Electronic Components Div. of Murata Erie Oceanside, New York	77542 Ray-O-Vac Corp Madison, Wisconsin	80183 Sprague Products (Now 56289)
72228 AMCA International Corp. Continental Screw Div. New Bedford, Massachusetts	73905 FL Industries Inc. San Jose, California	77638 General Instrument Corp. Rectifier Div. Brooklyn, New York	80294 Boums Instruments Inc. Riverside, California
72259 Nytronics Inc. New York, New York	73949 Guardian Electric Mfg. Co. Chicago, Illinois	77900 Shakeproof Lock Washer Co. (Now 78189)	80583 Hammerlund Mfg. Co. Inc. Paramus, New Jersey
72619 Amperex Electronic Corp. Dialight Div. Brooklyn, New York	74199 Quam Nichols Co. Chicago, Illinois	77969 Rubbercraft Corp. of CA Ltd. Torrance, California	80640 Computer Products Inc. Stevens-Arnold Div. South Boston, Mass.
72653 G C Electronics Co. Div. of Hydrometals Inc. Rockford, Illinois	74217 Radio Switch Co. Marlboro, New Jersey	78189 Illinois Tool Works Inc. Shakeproof Div. Elgin, Illinois	81073 Grayhill Inc. La Grange, Illinois
72794 Dzus Fastner Co. Inc. West Islip, New York	74306 Piezo Crystal Co. Div. of PPA Industries Inc. Carlisle, Pennsylvania	78277 Sigma Instruments Inc. South Braintree, Mass.	81312 Litton Systems Inc. Winchester Electronics Div. Watertown, Connecticut
72928 Gulton Industries Inc. Gudeman Div. Chicago, Illinois	74542 Hoyt Elect.Instr. Works Inc. Penacook, New Hampshire	78290 Struthers Dunn Inc. Pitman, New Jersey	81439 Therm-O-Disc Inc. Mansfield, Ohio
72982 Murata Erie N. America Inc. Erie, Pennsylvania	74840 Illinois Capacitor Inc. Lincolnwood, Illinois	78553 Eaton Corp. Engineered Fastener Div. Cleveland, Ohio	81483 International Rectifier Corp. Los Angeles, California
73138 Beckman Industrial corp. Helipot Div. Fullerton, California	74970 Johnson EF Co. Waseca, Minnesota	78592 Stoeger Industries South Hackensack, New Jersey	81590 Korry Electronics Inc. Seattle, Washington
73168 Penwal Inc. Ashland, Massachusetts	75042 TRW Inc. IRC Fixed Resistors Philadelphia, Pennsylvania	79136 Waldes Kohinoor Inc. Long Island City, New York	81741 Chicago Lock Co. Chicago, Illinois
73293 Hughes Aircraft Co. Electron Dynamics Div. Torrance, California	75297 Litton Systems Kester Solder Div. Chicago, Illinois	79497 Western Rubber Co. Goshen, Indiana	82227 Aixpax Corp. Cheshire Div. Cheshire, Connecticut
	75376 Kurz-Kasch Inc. Dayton, Ohio		82240 Simmons Fastner Corp. Albany, New York

Federal Supply Codes for Manufacturers (cont)

82305 Palmer Electronics Corp. South Gate, California	84171 Arco Electronics Commack, New York	89536 John Fluke Mfg. Co., Inc. Everett, Washington	91802 Industrial Devices Inc. Edgewater, New Jersey
82389 Switchcraft Inc. Sub of Raytheon Co. Chicago, Illinois	84411 American Shizuki TRW Capacitors Div. Ogallala, Nebraska	89597 Fredericks Co. Huntingdon Valley, Penna.	91833 Keystone Electronics Corp. New York, New York
82415 Airtax Corp Frederick Div. Frederick, Maryland	84613 FIC Corp. Rockville, Maryland	89709 Bunker Ramo-Eltra Corp. Amphenol Div. Broadview, Illinois	91836 King's Electronics Co. Inc. Tuckahoe, New York
82872 Roanwell Corp. New York, New York	84682 Essex Group Inc. Peabody, Massachusetts	89730 General Electric Lamp Div. Newark, New Jersey	91929 Honeywell Inc. Micro Switch Div. Freeport, Illinois
82877 Rotron Inc. Custom Div. Woodstock, New York	85367 Bearing Distributing Co. San Francisco, California	90201 Mailory Capacitor Co. Sub of Emhart Industries Inc. Indianapolis, Indiana	91934 Miller Electric Co. Woonsocket, Rhode Island
82879 ITT Royal Electric Div. Pawtucket, Rhode Island	85372 Bearing Sales Co. Los Angeles, California	90215 Best Stamp & Mfg. Co. Kansas City, Missouri	91984 Maida Development Co. Hampton, Virginia
83003 Varo Inc. Garland, Texas	85480 W. H. Brady Co. Industrial Product Milwaukee, Wisconsin	90303 Duracell Inc. Technical Sales & Marketing Bethel, Connecticut	91985 Norwalk Valve Co. S. Norwalk, Connecticut
83014 Hartwell Corp. Placentia, California	85932 Electro Film Inc. Valencia, California	90303 Duracell Inc. Technical Sales & Marketing Bethel, Connecticut	92914 Alpha Wire Corp. Elizabeth, New Jersey
83055 Signalite Fuse Co. (Now 71744)	86577 Precision Metal Products Co. Peabody, Massachusetts	91094 Essex Group Inc. Suflex/IWP Div. Newmarket, New Hampshire	93332 Sylvania Electric Products Semiconductor Products Div. Woburn, Massachusetts
83058 TRW Assemblies & Fasteners Group Fasteners Div. Cambridge, Massachusetts	86684 Radio Corp. of America (Now 54590)	91247 Illinois Transformer Co. Chicago, Illinois	94144 Raytheon Co. Microwave & Power Tube Div. Quincy, Massachusetts
83259 Parker-Hannifin Corp. O-Seal Div. Culver City, California	86928 Seastrom Mfg. Co. Inc. Glendale, California	91293 Johanson Mfg. Co. Boonton, New Jersey	94222 Southco Inc. Concordville, Pennsylvania
83298 Bendix Corp. Electric & Fluid Power Div. Eatonsville, New Jersey	87034 Illuminated Products Inc. (Now 76854)	91462 Alpha Industries Inc. Logansport, Indiana	94988 Wagner Electric Corp. Sub of McGraw-Edison Co. Whippany, New Jersey
83315 Hubbell Corp. Mundelein, Illinois	88219 GNB Inc. Industrial Battery Div. Langhorne, Pennsylvania	91502 Associated Machine Santa Clara, California	95146 Alco Electronic Products Inc. Switch Div. North Andover, Massachusetts
83330 Kulka Smith Inc. A North American Philips Co. Manasquan, New Jersey	88245 Winchester Electronics Litton Systems-Usecos Div. Van Nuys, California	91506 Augat Inc. Attleboro, Massachusetts	95263 Leecraft Mfg. Co. Long Island City, New York
83478 Rubbercraft Corp. of America West Haven, Connecticut	88486 Triangle PWC Inc. Jewitt City, Connecticut	91507 Froeliger Machine Tool Co. Stockton, California	95275 Vitramon Inc. Bridgeport, Connecticut
83553 Associated Spring Bames Group Gardena, California	88690 Essex Group Inc. Wire Assembly Div. Dearborn, Michigan	91637 Dale Electronics Inc. Columbus, Nebraska	95303 RCA Corp. Receiving Tube Div. Cincinnati, Ohio
83740 Union Carbide Corp. Battery Products Div. Danbury, Connecticut	89020 Amerace Corp. Buchanan Crimptool Products Div. Union, New Jersey	91662 Elco Corp. A Gulf Western Mfg. Co. Connector Div. Huntingdon, Pennsylvania	95348 Gordo's Corp. Bloomfield, New Jersey
	89265 Potter-Brumfield (See 77342)	91737 ITT Cannon/Gremar (Now 08718)	95354 Methode Mfg. Corp. Rolling Meadows, Illinois

Federal Supply Codes for Manufacturers (cont)

95573
Campion Laboratories Inc.
Detroit, Michigan

95712
Bendix Corp.
Electrical Comp. Div.
Franklin, Indiana

95987
Weckesser Co. Inc.
(Now 85480)

96733
SFE Technologies
San Fernando, California

96853
Gulton Industries Inc.
Measurement & Controls Div.
Manchester, New Hampshire

96881
Thomson Industries Inc.
Port Washington, New York

97525
EECO Inc.
Santa Ana, California

97540
Whitehall Electronics Corp.
Master Mobile Mounts Div.
Fort Meyers, Florida

97913
Industrial Electronic
Hardware Corp.
New York, New York

97945
Pennwalt Corp.
SS White Industrial Products
Piscataway, New Jersey

97966
CBS
Electronic Div.
Danvers, Massachusetts

98094
Machlett Laboratories Inc.
Santa Barbara, California

98159
Rubber-Teck Inc.
Gardena, California

98278
Malco A Microdot Co.
South Pasadena, California

98291
Sealectro Corp.
BICC Electronics
Trumbull, Connecticut

98372
Royal Industries Inc.(Now 62793)

98388
Lear Siegler Inc.
Accurate Products Div.
San Deigo, California

99120
Plastic Capacitors Inc.
Chicago, Illinois

99217
Bell Industries Inc.
Elect. Distributor Div.
Sunnyvale, California

99378
ATLEE of Delaware Inc.
N. Andover, Massachusetts

99392
Mepco/Electra Inc.
Roxboro Div.
Roxboro, North Carolina

99515
Electron Products Inc.
Div. of American Capacitors
Duarte, California

99779
Bunker Ramo- Eltra Corp.
Barnes Div.
Lansdown, Pennsylvania

99800
American Precision Industries
Delevan Div.
East Aurora, New York

99942
Mepco/Centralab
A North American Philips Co.
Milwaukee, Wisconsin

U.S. SALES OFFICE AREAS

AL, Huntsville

John Fluke Mfg. Co., Inc.
4920J Corporate Drive
Huntsville, AL 35805-6202
(205) 837-0581

AZ, Phoenix

John Fluke Mfg. Co., Inc.
2211 S. 48th Street
Suite B
Tempe, AZ 85282
(602) 438-8314

Tucson

(602) 790-9881

CA, Southern

John Fluke Mfg. Co., Inc.
P.O. Box 19676
Irvine, CA 92713-9676
16969 Von Karman
Suite 100
Irvine, CA 92714
(714) 863-9031

Burbank

John Fluke Mfg. Co., Inc.
2020 N. Lincoln Street
Burbank, CA 91504
(213) 849-7181

Northern

John Fluke Mfg. Co., Inc.
2300 Walsh Ave., Bldg. K
Santa Clara, CA 95051
(408) 727-0513

San Diego

(619) 292-7656

CO, Denver

John Fluke Mfg. Co., Inc.
14180 East Evans Ave.
Aurora, CO 80014
(303) 695-1000

CT, Hartford

John Fluke Mfg. Co., Inc.
Glen Locken East
41-C New London Turnpike
Glastonbury, CT 06033
(203) 659-3541

DC, Washington

(301) 770-1570

FL, Clearwater

(813) 799-0087

Miami

(305) 462-1380

Orlando

John Fluke Mfg. Co., Inc.
940 N. Fern Creek Ave.
Orlando, FL 32803
(305) 896-4881

Tampa

(813) 251-9211

GA, Atlanta

John Fluke Mfg. Co., Inc.
2700 Deik Rd., Suite 150
Marietta, GA 30067
(404) 953-4747

IL, Chicago

John Fluke Mfg. Co., Inc.
1150 West Euclid Ave.
Palatine, IL 60067
(312) 705-0500

IN, Indianapolis

John Fluke Mfg. Co., Inc.
8777 Purdue Rd.
Suite 101
Indianapolis, IN 46268
(317) 875-7870

LA, Baton Rouge

(504) 924-1203

New Orleans

(504) 455-0814

MA, Boston

John Fluke Mfg. Co., Inc.
Middlesex Tech Center
900 Middlesex Turnpike
Building 8
Billerica, MA 01821
(617) 663-2400

MD, Baltimore

(301) 792-7060

Rockville

John Fluke Mfg. Co., Inc.
5640 Fishers Lane
Rockville, MD 20852
(301) 770-1570

MI, Detroit

John Fluke Mfg. Co., Inc.
33031 Schoolcraft
Livonia, MI 48150
(313) 522-9140

MN, Bloomington

John Fluke Mfg. Co., Inc.
1801 E. 79th St., Suite 9
Bloomington, MN 55420
(612) 854-5526

MO, St. Louis

John Fluke Mfg. Co., Inc.
11756 Borman Drive
Suite 160
St. Louis, MO 63146
(314) 993-3805

NC, Greensboro

John Fluke Mfg. Co., Inc.
1310 Beaman Place
Greensboro, NC 27408
(919) 273-1918

NJ, Paramus

John Fluke Mfg. Co., Inc.
P.O. Box 930
Paramus, NJ 07653-0930
West 75 Century Road
Paramus, NJ 07652
(201) 262-9550

NM, Albuquerque

(505) 881-3550

NY, Rochester

John Fluke Mfg. Co., Inc.
4515 Culver Road
Rochester, NY 14622
(716) 323-1400

OH, Cleveland

John Fluke Mfg. Co., Inc.
7830 Freeway Circle
Middleburg Heights, OH 44130
(216) 234-4540

Dayton

John Fluke Mfg. Co., Inc.
5450 Far Hills Avenue
Suite 111
Kettering, OH 45429
(513) 436-2224

OK, Northeast

(918) 749-0190

OR, Portland

(503) 227-2042

PA, Philadelphia

John Fluke Mfg. Co., Inc.
200 Lindenwood Drive
Malvern, PA 19355
(215) 647-9550

Pittsburgh

(412) 261-5171

TX, Austin

(512) 459-3344

Dallas

John Fluke Mfg. Co., Inc.
1801 Royal Lane
Suite 307
Dallas, TX 75229
(214) 869-0311

El Paso

(915) 533-3508

Houston

(713) 240-5995

San Antonio

John Fluke Mfg. Co., Inc.
10417 Gulfdale
San Antonio, TX 78216
(512) 340-0498

UT, Salt Lake City

(801) 268-9331

WA, Seattle

John Fluke Mfg. Co., Inc.
5020 148th Ave. N.E.
Suite #110
Redmond, WA 98052
(206) 881-6966

U.S. Government Specialists

Army (301) 770-1570, MD
(203) 837-0581, AL

Navy (714) 863-9031, CA
(301) 770-1570, MD

USAF (513) 436-2224, OH
(512) 340-2621, TX

Security (301) 770-1570, MD

Service Center Areas

CA, Burbank (213) 849-4641

CA, Santa Clara (408) 727-0513

CO, Denver (303) 695-1000

FL, Orlando (305) 896-4881

IL, Chicago (312) 705-0500

MD, Rockville (301) 770-1576

NJ, Paramus (201) 262-9550

TX, Dallas (214) 869-2848

WA, Everett (206) 356-5560

For more information on Fluke products or Sales Offices you may dial (800) 426-0361 toll-free in most of the U.S.A.
From Alaska, Hawaii, or Washington phone (206) 356-5400. From Canada and other countries phone (206) 356-5500.



John Fluke Mfg. Co., Inc., P.O. Box C9090, Everett, WA 98206
Fluke (Holland) B.V., P.O. Box 2269, 5600 CG, Eindhoven, The Netherlands. Phone (040) 458045
Litho in U.S.A. 11/87

INTERNATIONAL SALES OFFICES

Argentina •

Coasin S.A.
Virrey del Pino 4071 DPTO E-65
1430 CAP FED
Buenos Aires, Argentina
Tel: 54-1-552-5248
TLX: (390) 22284 COASN AR

Asia

Fluke Asia Ltd.
Shun Tak Centre, Room 1501
200 Connaught Road
Central, Hong Kong
Tel: 852 5 482116
TLX: (780) 87058 FLUKE
FAX: (852) 5-479863

Australia •

Elmeasco Instruments Pty, Ltd.
P.O. Box 30
Concord, N.S.W. 2137
Australia
Tel: 61-2-736-2888
TLX: (790) 25887 A/B: ELSOCAA 25887
FAX: 61-2-733663

Elmeasco Instruments Pty, Ltd.
P.O. Box 623
12 Maroonah Highway
Ringwood, Victoria 3134
Australia
Tel: 61-3-879-2322
TLX: (790) 30418 A/B: ELTENTAA 30418
FAX: (61) (3) 879-4310

Elmeasco Instruments Pty, Ltd.
P.O. Box 274
Salisbury, Queensland 4107
Australia
Tel: 61-7-875-1444
TLX: (790) 44062 A/B: ELMQLDAA44062

Elmeasco Instruments Pty, Ltd.
P.O. Box 154
Prospect, South Australia 5082
Tel: 61-8-344-9000 TLX: (790) A/B: 87519

Elmeasco Instruments Pty, Ltd.
P.O. Box 413
Scott House
46-48 Kings Park Road
West Perth, Western Australia 6005
Australia
Tel: 61-9-481-1500
TLX: (790) 94765 A/B: ASECSAA 94765
FAX: (61) (9) 322-2075

Austria •

Walter Rekirsch Elektronische
Geräte GmbH & Co.
Vertrieb KG
Obachgasse 28
1220 Vienna, Austria
Tel: 43-222-25-36-26
TLX: (847) 134759
FAX: 43-222-25-72-75

Bahrain •

Basma W.L.L.
P.O. Box 5701
Manama, Bahrain
Tel: 973-251364; TLX: (955) 9003
FAX: (965) 245218

Bangladesh •

Motherland Corporation
24 Hatkhola Road, Tikatuli
Dacca-3, Bangladesh
Tel: 257249
TLX: (950) 642022 PCO BJ
Cable: "MOTHERLAND" DACCA

Belgium •

N.V. Philips
Industrial & Electro-Acoustic Systems
5600 MD Eindhoven
The Netherlands
Tel: 040-785539
Tlx: 35000 phtc nl
Fax: 040-785651

Bolivia •

Coasin Bolivia S.R.L.
Casilla 7295
La Paz, Bolivia
Tel: 591-2-40962
TLX: (336) 3233 COALAP BV
Cable: COALAP

Brazil •

ATP/HI-Tek Eletronica Ltda.
Al. Amazonas 422,
Alphaville, 06400, Barueri
Sao Paulo, Brazil
Tel: 55-11-421-5477;
TLX: (391) 1171413 HITK BR

Brunei •

Rank O'Connor's SDN BHD
No. 8 Blk D
Sufri Shophouse Complex
Mile 1 Jalan Tutong
Bandar Seri Begawan
Negara Brunei Darussalam
Tel: 673-2-23109 or 23557
TLX: (799) BU 2265 RANKOC

Canada •

Fluke Electronics Canada Inc.
101, 1144 - 29th Avenue N.E.
Calgary, Alberta T2E 7P1
Canada
Tel: (403) 291-5215
Fax: (403) 291-5219

Fluke Electronics Canada Inc.
400 Britannia Road East
Unit #1
Mississauga, Ontario L4Z 1X9
Tel: (416) 890-7600
Fax: (416) 890-6866

Fluke Electronics Canada Inc.
1255 Trans Canada Hwy.
Suite 130
Dorval, Quebec
H9P 2V4 Canada
Tel: (514) 685-0022
TLX: (514) 685-0039

Fluke Electronics Canada Inc.
1690 Woodward Drive
Suite 216
Ottawa, Ontario
K2C 3R8 Canada
Tel: (613) 723-9453
Fax: (613) 723-9458

Chile •

Intronica Chile, Ltda.
Casilla 16228 (Mail)
Santiago 9, Chile
Tel: 56-2-2321886
TLX: (332) 346351 INTRON CK

China, Peoples Republic of •

Fluke International Corporation
P.O. Box 9085
Beijing
People's Republic of China
Tel: 86-01-65-7281
TLX: (716) 222237 FBSC CN
Instrimpex - Fluke Service Center
57, Xisi Dong Da Jie
Xicheng-qu
Beijing
Peoples Republic of China
Tel: 86-01-65-7281

Colombia •

Sistemas E Instrumentacion, Ltda.
Carrera 13, No. 37-43, Of. 401
Ap. Aereo 29583
Bogota DE, Colombia
Tel: 57-232-4532
TLX: (396) 45787 COASN CO

Cyprus •

Chris Radiovision, Ltd.
P.O. Box 1989
Nicosia, Cyprus
Tel: 357-21-66121; TLX: (826) 2395

Cyprus, Northern •

Ucok Buroteknik
2C & 2D Muftu Ziyai Street
Lefkosa, Northern Cyprus
Mersin 10, Turkey
Tel: 90-741-357-20-71777
TLX: (821) 57267

Czechoslovakia •

Amtest Associates, Ltd.
Amtest House
75-79 Guildford Street
Chertsey, Surrey KT16 9AS
England
Tel: 44-9328-68355
TLX: (851) 928855 AMTEST G
Fax: 44-9328-61919

Denmark •

Tage Olsen A/S
Ballerup Byvej 222
2750 Ballerup
Denmark
Tel: 45-2-658111
TLX: (855) 35293 TOAS DK

Eastern European Countries •

Amtest Associates, Ltd.
Amtest House
75-79 Guildford Street
Chertsey, Surrey KT16 9AS
England
Tel: 44-9328-68355
TLX: (851) 928855 AMTEST G
Fax: 44-9328-61919
German Branch Office
Amtest Associates, Ltd.
Zugspitzstrasse 2A
P.O. Box 1107
8011 Vaterstetten
West Germany
Tel: 49-81-067117, TLX: (841) 528332

Ecuador •

Proteco Coasin Cia., Ltda.
P.O. Box 228-A
Ave. 12 de Octubre 2285
y Orellana
Quito, Ecuador
Tel: 593-2-529684
TLX: (393) 22085 ESIND

Egypt

Electronic Engineering Liaison Office
P.O. Box 2891 Horreya
11361 Heliopolis, Cairo
Egypt
Tel: 20-2-695705, TLX: (927) 22782

England

N.V. Philips
Industrial & Electro-Acoustic Systems
5600 MD Eindhoven
The Netherlands
Tel: 040-785539
Tlx: 35000 phtc nl
Fax: 040-785651

Fiji •

Awa New Zealand Limited
37 Freeston Road
Waiu Bay, P.O. Box 858
Suva, Fiji
Tel: 679-312079, TLX: (792) FJ2347
FAX: 679-314379

Finland •

Instrumentarium Elektronika
P.O. Box 64
02631 Espoo 63
Finland
Tel: 358-0-5281
TLX: (857) 124426 HAVUL SF
FAX: (358) 0-5021073
Teletex: (857) 8-100155 INSTRUE

France •

M.B. Electronique S.A.
606, Rue Fournay
P.O. Box 31
78530 BUC, France
Tel: 33-1-39-56-81-31
TLX: (842) 695414
Fax: (33) (1) 3956-53-44

German Branch Office

Amtest Associates, Ltd.
Zugspitzstrasse 2A
P.O. Box 1107
8011 Vaterstetten
West Germany
Tel: 49-81-067117
TLX: (841) 528332
Germany, West
N.V. Philips
Industrial & Electro-Acoustic Systems
5600 MD Eindhoven
The Netherlands
Tel: 040-785539
Tlx: 35000 phtc nl
Fax: 040-785651

Greece

Hellenic Scientific Representations Ltd.
11, Vrassida Street
Athens 612, Greece
Tel: 30-1-7211140, TLX: (863) 219330

Hong Kong •

Schmidt & Co (H.K.), Ltd
18th Floor, Great Eagle Centre
23 Harbour Road
Wanchai, Hong Kong
Tel: 852-5-8330-222
TLX: (780) 74766 SCHMC HX
FAX: 852-5-8918754

India •

Hinditron Services Pvt., Ltd.
69/A.L. Jagmohandas Marg
Bombay 400 006, India
Tel: 91-22-8121316, 8125344
TLX: (953) 1175326 HSPL IN

Bangalore Office

Hinditron Services Pvt., Ltd.
8th Main Road
33/44A Raj Mahal Vilas Extension
Bangalore 560 080, India
Tel: 91-812-363139
TLX: (953) 08452741
Cable: TEKHIND BANGALORE

Calcutta Office

Hinditron Services Pvt. Ltd.
5th Floor, Castle House
5/1A, Hungerford St.
Calcutta 700 017, India
Tel: 91-33-432628
TLX: (953) 214153

New Delhi Sales

Hinditron Services Pvt. Ltd.
204-206 Hemkunt Tower
98 Nehru Place
New Delhi, 110019, India
Tel: 91 (11) 6410380 or 6414493
TLX: (953) 3161458 HSPL IN

New Delhi Service

Hinditron Services Pvt., Ltd.
Field Service Center
15, Community Centre
Panchshila Park
New Delhi 110 017, India
Tel: 91 011 6433675

Cable: Tekcentre Delhi

Hyderabad Office
Hinditron Services Pvt. Ltd.
Field Service Center
Emerald Complex, 5th Floor
1-7-264
114 Sarojini Devi Road
Secunderabad 500 003, India
Tel: 91 842 821117
TLX: (953) 04256973 HSPL IN

Indonesia •

P.T. Lamda Triguna
P.O. Box 6/JATJG
Jakarta, 13001
Indonesia
Tel: 62 21 8195365
TLX: (796) 46171 LAYARIA

Iran •

Arma Baynelmeleli Co., Ltd.
P.O. Box 951570
Pasdaran-Tehran
Tel: 98-21-248717, TLX: (951) 213648

Ireland

N.V. Philips
Industrial & Electro-Acoustic Systems
5600 MD Eindhoven
The Netherlands
Tel: 040-785539
Tlx: 35000 phtc nl
Fax: 040-785651

Israel •

R.D.T. Electronics Engineering Ltd.
P.O. Box 43137
Tel Aviv 61430
Israel
Tel: (3) 972-3-483211
TLX: (922) 371452 RDT IL
Fax: 972-3-492190

Italy •

Sistrel S.p.A.
Via le Erminio Spalla 41
00142 Rome, Italy
Tel: 39-6-504-1367, TLX: (843) 625857
Fax: (39) 6-504137



John Fluke Mfg. Co., Inc. / PO Box C9090 / Everett, WA 98206 / (206) 356 5400

Litho in U.S.A. 11/87

Milan Office
Sistrel S.p.A.
Via Pelizza da Volpedo 59
20092 Cinisello Balsamo
Milan, Italy
Tel: 39-2-6181893, TLX: (843) 334643
Fax: (39) 2-6182440

Naples Office
Sistrel S.p.A.
Via Cintia
Parco S. Paolo 35
80126 Naples, Italy
Tel: 39-81-7678700
Fax: (39) 81-7661361

Japan ●
John Fluke Mfg. Co., Inc.
Japan Branch
Sumitomo Higashi Shinbashi Bldg.
1-1-11 Hamamatsucho
Minato-ku, Tokyo 105, Japan
Tel: 81-3-434-0181
TLX: (781) 2424331 FLUK JPJ
FAX: 81-3-434-0170

Osaka Sales Office
John Fluke Mfg. Co., Inc.
Japan Branch
Katsushige Building
2-45 Kohraibashi
Higashi-ku, Osaka 541
Japan
Tel: 81-6-229-0871 FAX: 81-6-229-1098

Korea, Republic of ●
Myoung Corporation
Yeo Eui Do P.O. Box 14
Seoul, Korea
Tel: 82-2-784-9942 MYOUNG
TLX: (787) K24283
FAX: (82) 2-784-2387

Kuwait ■
Al Bahar International Group
P.O. Box 26672 Safat
13127 Safat, Kuwait
Kuwait, Arabian Gulf
Tel: 965-848601, 847598
TLX: (959) 44822

Lebanon and Jordan ■
Mabek (Electronics Division)
P.O. Box 13-5657
Beirut, Lebanon
Tel: 812523
TLX: (923) 22889 LIBANK LE

Malaysia ●
Mecomb Malaysia Sdn Bhd
P.O. Box 24
46700 Petaling Jaya, Selangor, Malaysia
Tel: 60-3-774-3422
TLX: (784) MA37764 MECOMB
Fax: (6) 03-774-3414

Malta ■
Fabian Enterprises
20, Msida Road
Gzira, Malta
Tel: 513283/40216, TLX: (838) 1837

Mexico ●
Mexicana de Electronica
Industrial, S.A. (Mexel)
Diagonal No. 27
Entre Calle de Eugenia Y Ave
Colonia del Valle
C.P. 03100, Mexico
Tel: (905) 660-4323
TLX: (383) 1771038 FAIRME
Executone De Monterrey, S.A.
Ave. Gonzalitos NTE 545
Monterrey N.L., Mexico
Tel: 90-5-480400, 472625
TLX: (383) 382659

Morocco ■
Oussama S.A.
Angie Boulevard Emile Zola et
Rue Rethel
P.O. Box 2007 Casa
Casablanca
Morocco
Tel: 212-24-13-38, TLX: (933) 28879 M

Nepal ●
Associated Enterprises
GPO Box 790, Pyaphal Tole
Kathmandu, Nepal
Tel: 13868, TLX: (947) 2568 (ASOENT NP)

Netherlands
N.V. Philips
Industrial & Electro-Acoustic Systems
5600 MD Eindhoven
The Netherlands
Tel: 040-785539
Tlx: 35000 phtc nl
Fax: 040-785651

New Zealand ●
Auckland Office
Northrop Instruments & Systems, Ltd.
459 Khyber Pass Road
Private Bag, Newmarket
Auckland 1, New Zealand
Tel: 64-9-501-801, 501-219
TLX: (791) 21570
FAX: 64-9-543430

Wellington Office
Northrop Instruments & Systems Ltd.
Information Technology Group
First Floor, Northrop Bldg.
189-191 Willis Street
P.O. Box 2406
Wellington, New Zealand
Tel: 64-4-856-658
TLX: (791) 3380

Christchurch Office
Northrop Instruments & Systems Ltd.
Information Technology Group
110 Mandeville Street
P.O. Box 8388
Christchurch, New Zealand
Tel: 64-3-488-874
TLX: (791) 4801

Norway ■
Morgenstjerne & Co A/S
Konghellegate 3
P.O. Box 6688, Rodelokka
Oslo 5, Norway
Tel: (2) 356110, TLX: (856) 71719

Oman ■
OHI Telecommunications LLC
P.O. Box 889
Muscat, Oman
Tel: 968-603606
TLX: (926) 5052 TELECOM ON

Pakistan ●
International Operations (PAK), Ltd.
505 Muhammadi House
I.I. Chundrigar Road
P.O. Box 5323, Karachi, Pakistan
Tel: 92-21-221127, TLX: (952) 24494 PIO PK

Peru ●
Importaciones y Representaciones
Electronicas S.A.
Avda. Franklin D. Roosevelt 105
Lima 1, Peru
Tel: 51-14-28-8650
TLX: (394) 25663 PE IREING

Philippines, Republic of ●
Spark Radio & Electronics, Inc.
Greenhills P.O. Box 610
San Juan, Metro Manila, Zip 3113
Philippines
Tel: 63-2-775192, 704096
TLX: (722 or 732) 27901 RLA PH

Portugal ■
Decada Espectral
Equipamentos de Electronica
Av. Bombeiros Voluntarios
Lote 102B, Miraflores/Aiges
1495 Lisbon, Portugal
Tel: 351-1-4103420, TLX: (832) 15515

Romania ■
Amtest Associates Ltd.
Amtest House
75-79 Guildford Street
Chertsey, Surrey KT16 9AS
England
Tel: 44-9328-68355, TLX: (851) 928855
FAX: 44-9328-61919

Saudi Arabia ■
Electronic Equipment Marketing Co.
P.O. Box 3750
Riyadh, Saudi Arabia
Tel: 966-1-477-1650
TLX: (928) 401120 ZUHAIR SJ

Scotland
N.V. Philips
Industrial & Electro-Acoustic Systems
5600 MD Eindhoven
The Netherlands
Tel: 040-785539
Tlx: 35000 phtc nl
Fax: 040-785651

Singapore, Republic of ●
Rank O'Connor's (PTE) Ltd.
O'Connor House
98 Pasir Panjang Road
Singapore 0511
Republic of Singapore
Tel: 65-4737944, TLX: (786) RS21023 OCONSIN
FAX: 4724508 CABLE CINECOM SINGAPORE

South Africa ●
Protea PNI
P.O. Box 39127
Bramley 2018
Republic of South Africa
Tel: 27-11-786-3647
TLX: (960) 4-24409 SA
FAX 27-11-786-1807

Spain ■
ESSA
Equipos y Sistemas S.A.
C/Apolonio Morales, 13-B
Madrid 16, Spain
Tel: 34-1-458-0150
TLX: (831) 42856 EYS E

Sri Lanka ●
Computerlink Data Systems, Ltd.
331 Union Place
Colombo 2, Sri Lanka
Tel: 94-1-28641
TLX: (954) 22455 COLINK CE

Sweden
N.V. Philips
Industrial & Electro-Acoustic Systems
5600 MD Eindhoven
The Netherlands
Tel: 040-785539
Tlx: 35000 phtc nl
Fax: 040-785651

Switzerland ■
Traco Electronic AG
Jenatschstrasse 1
8002 Zurich
Switzerland
Tel: 41-1-201-0711
TLX: (845) 815570 TRCOCH

Syria ■
Mabek (Electronics Division)
P.O. Box 4238
Damascus, Syria

Taiwan ●
Schmidt Electronics Corp.
5th Fl, Cathay Min Sheng
Commercial Building,
344 Min Sheng East Road
Taipei Taiwan R.O.C.
Tel: 886-2-501-3468
TLX: (785) 11111 SCHMIDT
Fax: (886) 2-502-9692

Thailand ●
Measuretronix Ltd.
2102/63 Ramkamhaeng Rd.
Huamark Bangkok 10240
Thailand
Tel: 66 (2) 3742516, 3741632
TLX: (788) 82796 HUAMARK TH

Tunisia ■
Selep S.A.R.L.
6, Rue de Sparte
Tunis - 1000 RP
Tunisia
Tel: 216-1-248093, TLX: (934) 13030

Turkey ■
Erkman Elektronik Aletler
Ticaret Anonim Sirketi
Necatibey Cad 92/3
Karakoy, Istanbul, Turkey
Tel: 90 (11) 441546, TLX: (821) 24399

United Arab Emirates ■
Harris Al-Afag, Ltd.
P.O. Box 8141
Kamal Hamza Bldg.
Traffic Police Road
Dubai, U.A.E.
Tel: 971-4-283625
TLX: (958) 48168 AFAQEM
Al-Sanani Cen. Trad. Est.
P.O. Box 7187
Abu-Dhabi, U.A.E.
Tel: 971-2-821370, TLX: (958) 23966

Uruguay ●
Coasin Uruguay S.A.
Casilla de Correo 1400
Libertad 2529
Montevideo, Uruguay
Tel: 598-2-789204, 789015
TLX: (398) UY23010 COAUR

USSR
Amtest Associates Ltd.
Amtest House
75-79 Guildford Street
Chertsey, Surrey KT16 9AS
England
Tel: 44-9328-68355, TLX: (851) 928855
FAX: 44-9328-61919

Venezuela ●
Coasin C.A.
Calle 9 Con Calle 4, Edif Eductorbi.
Apartado de Correos NR-70.136
Los Ruices
Caracas 1070-A, Venezuela
Tel: 58 (2) 241-03-09
TLX: (395) 21027 EMVEN VC

Yugoslavia ■
Amtest Associates Ltd.
Amtest House
75-79 Guildford Street
Chertsey, Surrey KT16 9AS
England
Tel: 44-9328-68355, TLX: (851) 928855
FAX: 44-9328-61919

■ Supplied and Supported by —
Fluke (Holland) B.V.
P.O. Box 2269
5600 CG Eindhoven
The Netherlands
Tel: (040) 45805, TLX: (844) 51846
FAX: 31-40-457515

● Supplied and Supported by —
Fluke International Corporation
P.O. Box C9090
Everett, WA 98206 U.S.A.
Tel: (206) 356-5500
TLX: 185103 FLUKE UT
FAX: 206-356-5116

The following countries are
represented by:
Fluke (Holland) B.V.
P.O. Box 2269
5600 CG Eindhoven
The Netherlands
Tel: (040) 45805, TLX: 51846
FAX: 31-40-457515

Abu Dhabi	Mauritania
Afghanistan	Menorca
Albania	Mongolia
Algeria	Niger
Angola	Nigeria
Benin	Qatar
Bornholm	Rodhos
Botswana	Russia
Chad	Sardinia
Corsica	Saudia Arabia
Czechoslovakia	Scotland
Dubai	Senegal
Ethiopia	Sierra Leone
Guinea	Somalia
Ibiza	Togo
Iceland	Upper Volta
Iraq	Wales
Kuwait	Wstn Sahara
Liberia	Yemen
Libya	Zaire
Luxembourg	Zambia
Maderia	Zimbabwe
Mallorca	



TECHNICAL SERVICE CENTERS

U.S.A.

CA, Burbank

John Fluke Mfg. Co., Inc.
(213) 849-4641

CA, Santa Clara

John Fluke Mfg. Co., Inc.
(408) 727-8121

CO, Denver

John Fluke Mfg. Co., Inc.
(303) 695-1000

FL, Orlando

John Fluke Mfg. Co., Inc.
(305) 896-4881

IL, Palatine

John Fluke Mfg. Co., Inc.
(312) 705-0500

MD, Rockville

John Fluke Mfg. Co., Inc.
(301) 770-1576

NJ, Paramus

John Fluke Mfg. Co., Inc.
(201) 262-9550

TX, Dallas

John Fluke Mfg. Co., Inc.
(214) 869-0311

WA, Seattle

John Fluke Mfg. Co., Inc.
(206) 356-5560

Other Countries

Argentina, Buenos Aires

Coasin S.A.
Tel: 552-5248
TLX: (390) 22284

Australia, Brisbane

Elmeasco Instruments Pty. Ltd.
Tel: 552-5248

Australia, Concord

Elmeasco Instruments Pty. Ltd.
Tel: 736-2888
TLX: (790) AA25887

Australia, Ringwood

Elmeasco Instruments Pty. Ltd.
Tel: 879-2322
TLX: (790) AA36206

Austria, Vienna

Walter Rekirsch
Elektronische Gerate GmbH & Co.
Tel: 253626
TLX: (847) 134759

Belgium, Brussels

Fluke (Belgium) NV/SA
Tel: 2164090
TLX: (846) 26312

Brazil, Sao Paulo

Hi-Tek Electronica Ltda.
Tel: 421-5477
TLX: (1391) 1171413

Canada, Calgary

Fluke Electronics Canada Inc.
Tel: (403) 291-5215
Fax: (403) 291-5219

Canada, Mississauga

Fluke Electronics Canada Inc.
Tel: (416) 890-7600
Fax: (416) 890-6866

Canada, Montreal

Fluke Electronics Canada Inc.
Tel: (514) 685-0022
Fax: (514) 685-0039

Canada, Ottawa

Fluke Electronics Canada Inc.
Tel: (613) 723-9453
Fax: (613) 723-9458

Chile, Santiago

Intronica Chile Ltda.
Tel: 232 1886
TLX: (332) 346351

China, Peoples Republic of

Instrimpex - Fluke Service Center
Tel: 65-7281

Colombia, Bogota

Sistemas E Instrumentacion, Ltda.
Tel: 232-4532
TLX: (396) 45787

Denmark, Ballerup

Tage Olson A/S
Tel: 658111
TLX: (855) 35293

Ecuador, Quito

Proteco Coasin Cia., Ltda.
Tel: 526759
TLX: (393) 2865

Egypt and Sudan

Electronic Engineering Liaison Ofc
Tel: 2455705
TLX: (927) 22782

England, Chertsey, Surrey

Amtest Associates, Ltd
Tel: 68355

England, Watford, Herts

Fluke (Great Britain) Ltd
Tel: 40511
TLX: (851) 934583

Finland

Instrumentarium Elektronikka
Tel: 358-0-5281
TLX: (857) 124426

France

M.B. Electronique S.A.
Tel: 1-39-56-81-31
TLX: (842) 695414

Greece, Athens

Hellenic Scientific Representations
Tel: 7211140
TLX: (863) 219330

Hong Kong, Wanchai

Schmidt & Co (H.K.) Ltd.
Tel: 8330-222
TLX: (780) 74766

India, Bangalore

Hinditron Services Pvt. Ltd.
Tel: 363139
TLX: (953) 845741

India, Bombay

Hinditron Services Pvt. Ltd.
Tel: 6300043
TLX: (953) 11-72247

India, New Delhi

Hinditron Services Pvt. Ltd.
Tel: 6433675
TLX: (953) 316458

India, Secunderbad

Hinditron Services Pvt. Ltd.
Tel: 821117
TLX: (953) 1556973

Indonesia, Jakarta Pusat

P.T. Lamda Triguna
Tel: 8195365
TLX: 46171 LAYARIA

Israel, Tel Aviv

R.D.T. Electronics Engineering Ltd.
Tel: 483211
TLX: (922) 371452

Italy, Milan

Sistrel S.p.A.
Tel: 6181893
TLX: (843) 334643

Japan, Tokyo

John Fluke Mfg. Co., Inc.
Japan Branch
Tel: 434-0181
TLX: (781) 242-4331

Korea, Republic of

Myoung Corp.
Tel: 784-9942
TLX: MYOUNG K24283

Malaysia, Selangor

Mecomb Malaysia Sdn. Bhd.
Tel: 3-743422
TLX: (784) MA37764

Mexico

Mexicana de Electronica
Industrial, S.A. (Mexel)
Tel: 5-660-4323
TLX: (383) 1771038

Netherlands, Tilburg

Fluke (Nederland) B.V.
Tel: 352455
TLX: (844) 52683

New Zealand, Auckland

Northrop Instruments
& Systems Ltd.
Tel: 501-801
TLX: (791) NZ21570

New Zealand, Wellington

Northrop Instruments
& Systems Ltd.
Tel: 856-658
TLX: (791) NZ3380

Norway, Oslo

Morgenstjerne & Co. A/S
Tel: 356110
TLX: (856) 71719

Pakistan, Karachi

International Operations (PAK), Ltd.
Tel: 221127, 239052
TLX: (952) 24494

Peru, Lima

Importaciones Y Representaciones
Electronicas S.A.
Tel: 288650
TLX: (394) 25663

Philippines

Spark Radio & Electronics Corp.
Tel: 2-775192
TLX: (722) 27901

Portugal, Lisboa

Equipamentos de Electronica e
Cientificos, SARL.
Tel: 2103420
TLX: (832) 15515

Republic of Singapore

Rank O'Connor's (PTE) Limited
Tel: 4737944
TLX: (786) RS21023

Republic of South Africa, Bramley

Protea PNI
Tel: 11-786-3647
TLX: (960) 4-24409

Spain, Madrid

Equipos y Sistemas S.A.
Tel: 458-0150
TLX: (831) 42856

Sweden, Vallingby

Kaliber AB
Tel: 380350
TLX: (854) 14077

Switzerland, Zurich

Traco Electronic AG
Tel: 2010711
TLX: (845) 815570

Taiwan, Taipei

Schmidt Electronics Corp.
Tel: 5013468
TLX: (785) 11111

Thailand, Bangkok

Measuretronix Ltd.
Tel: 374-2516
TLX: (788) 82796

Turkey, Istanbul

Erkman Elektronik Aletler
Tel: 441546
TLX: (821) 24399

Uruguay, Montevideo

Coasin Uruguay S.A.
Tel: 789015
TLX: (398) UY23010

Venezuela, Caracas

Coasin C.A.
Tel: 241-0309
TLX: (395) 21027

West Germany, Ismaning/Munich

Fluke (Deutschland) GmbH
Tel: 9605240
TLX: (841) 0522472



John Fluke Mfg. Co., Inc., P.O. Box C9090, Everett, WA 98206

Fluke (Holland) B.V., P.O. Box 2269, 5600 CG, Eindhoven, The Netherlands. Phone (040) 458045

Litho in U.S.A. 11/87